



Moving forward in every field

NOŽE

NOŽYKI, TULEJKI
Quick Reference Guide



SPIS TREŚCI

Noże do kosiarki rotacyjnej 01

Noże do sieczkarni 02

Tulejki do noża sieczkarni 03

About BEPCO

Wholesaler specialized in the sale of technical parts & accessories

Bepco Group is a worldwide leading supplier of parts and accessories for tractors and agricultural machinery.

Bepco Group is a truly global company with customers in over 100 countries worldwide and sales outside Europe contributing to over a third of revenues.

Bepco Group is also a member of TVH, the all-round supplier of quality parts and accessories for material handling, industrial vehicles and agricultural equipment.

Bepco has its own factories (Agrojan for parts harvesting) and sells high quality products

We've built our reputation on the quality of our products and continue to stand by this today. As the technical specialist in the industry, we offer the most extensive range of tractor parts for all makes and brands, including the widest and deepest range of engine parts available.

We've also established ourselves as experts in replacement glass, with over 8,000 references available for tractors, telescopics and combines.

In addition to our specialisms, we supply the full range required for most agricultural applications, be it workshop equipment, consumables, hydraulics or air conditioning.



01

Noże do kosiarki rotacyjnej

6-20

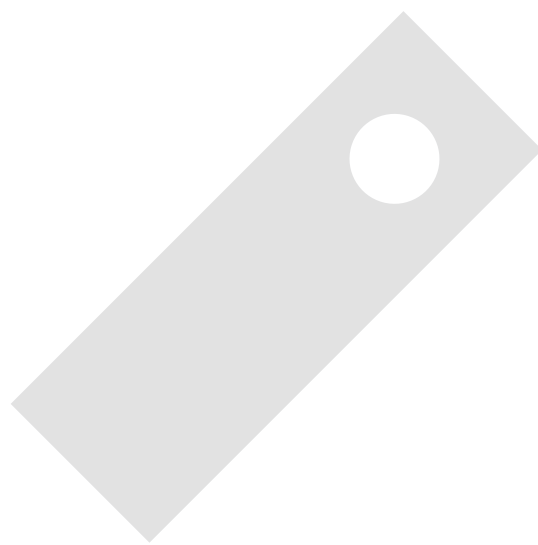

Noże do kosiarki rotacyjnej

TYPY NOŻYKÓW

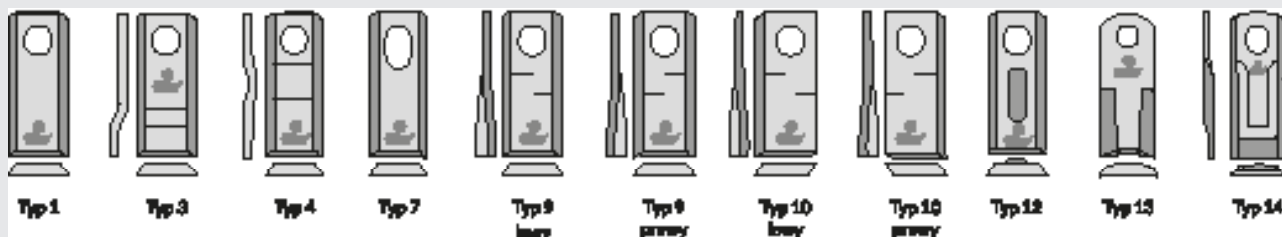

Pasuje do AMA

NR. AGV	WERSJA	NR. PORÓWNAWCZY	TYP	DŁUGOŚĆ x SZEROKOŚĆ (MM)	Ø OTWORU (MM)	GRUBOŚĆ (MM)	OPAK.
710110011	Nożyk	98D	1	98 x 40	19	3	25
710120082	Nożyk	98P	3	98 x 49	19	3	25

Pasuje do BCS

NR. AGV	WERSJA	NR. PORÓWNAWCZY	TYP	DŁUGOŚĆ x SZEROKOŚĆ (MM)	Ø OTWORU (MM)	GRUBOŚĆ (MM)	OPAK.
710120048	lewy	58031193	10	94 x 48	19	4	25
710120049	prawy	58031192	10	94 x 48	19	4	25
710120181	lewy	580290966	10	100 x 40	19	3	25
710120182	prawy	580290955	10	100 x 40	19	3	25
710110011		580290454	1	98 x 40	19	3	25

Pasuje do BELLON

NR. AGV	WERSJA	NR. PORÓWNAWCZY	TYP	DŁUGOŚĆ x SZEROKOŚĆ (MM)	Ø OTWORU (MM)	GRUBOŚĆ (MM)	OPAK.
710110010		108D	1	108 x 46	21	3	25

Pasuje do CLAAS

NR. AGV	WERSJA	NR. PORÓWNAWCZY	TYP	DŁUGOŚĆ x SZEROKOŚĆ (MM)	Ø OTWORU (MM)	GRUBOŚĆ (MM)	OPAK.
710110005	Nożyki	9775160	1	90 x 40	19	3	25
710120048	lewy	1043390	10	94 x 48	19	3	25
710120049	prawy	1043400	10	94 x 48	19	3	25
710110001	Nożyk	9782414	1	96 x 40	19	3	25
710100002	Nożyk	9781860	1	94 x 40	19	3	25
710110006	Nożyk	9492400	1	96 x 40	19	4	25
710120178	lewy	9468840	9	98 x 40	16,2	4,3	25
710120179	prawy	9468850	9	98 x 40	16,2	4,3	25
710120035	lewy	9527290, 9041787, 9047970	10	100 x 48	19	3	25
710120036	prawy	9527280, 9041777, 9047960	10	100 x 48	19	3	25
710130002	Nożyk	1040041,1	4	105 x 46	21	3	25
710120030	lewy	9041788	10	105 x 48	19	3	25
710120029	prawy	9041778	10	105 x 48	19	3	25
710120039	lewy	9492421	10	105 x 48	19	4	25

Noże do kosiarki rotacyjnej

Pasuje do CLAAS

NR. AGV	WERSJA	NR. PORÓWNAWCZY	TYP	DŁUGOŚĆ x SZEROKOŚĆ (MM)	Ø OTWORU (MM)	GRUBOŚĆ (MM)	OPAK.
710120040	prawy	9492411	10	105 x 48	19	4	25
710120053	lewy	1042660	10	106 x 48	21	3	25
710120054	prawy	1042670	10	106 x 48	21	3	25
710120060	lewy	105878	9	110 x 48	21	3	25
710120059	prawy	105873	9	110 x 48	21	3	25
710120034	lewy	9520430	10	115 x 47	19	4	25
710120033	prawy	9520420	10	115 x 47	19	4	25
710120038	lewy	1045550	9	122 x 45	18,2	4	25
710120037	prawy	1045560	9	122 x 45	18,2	4	25

Pasuje do DEUTZ FAHR / KVERBELAND

NR. AGV	WERSJA	NR. PORÓWNAWCZY	TYP	DŁUGOŚĆ x SZEROKOŚĆ (MM)	Ø OTWORU (MM)	GRUBOŚĆ (MM)	OPAK.
710120180.AGV	Nożyk	11019010282.00	1	83 x 40	19	3	25
710110005	Nożyki	06561543, 1-1019-010-271.20,MT52	1	90 x 40	19	3	25
710110001	Nożyk	06561542, 1-1012-030-115.00	1	96 x 40	19	3	25
710130001	Nożyki	06561544, 06561541, 11017010153.00	3	96 x 40	19	3	25
710120047	lewy	16502727,07	9	96 x 40	19	3	25
710120046	Nożykprawy	16502726,07	9	96 x 40	19	3	25
710120042	lewy	16503465	10	96 x 48	19	4	25
710120041	prawy	16503464	10	96 x 48	19	4	25
710120178	lewy	06566282	9	98 x 40	16,2	4,3	25
710120179	prawy	06566283	9	98 x 40	16,2	4,3	25

Pasuje do FARENDLØSE

NR. AGV	WERSJA	NR. PORÓWNAWCZY	TYP	DŁUGOŚĆ x SZEROKOŚĆ (MM)	Ø OTWORU (MM)	GRUBOŚĆ (MM)	OPAK.
710110001		00-011-054	1	96 x 40	19	3	25
710110011		00-011-069	1	98 x 40	19	3	25
710120177		00-01-070	3	98 x 40	19	3	25

Pasuje do FELLA

NR. AGV	WERSJA	NR. PORÓWNAWCZY	TYP	DŁUGOŚĆ x SZEROKOŚĆ (MM)	Ø OTWORU (MM)	GRUBOŚĆ (MM)	OPAK.
710120176.AGV	Nożyk	116948, 477016	1	85 x 40	19,5	4	25
710110005	Nożyki	477741	1	90 x 40	19	3	25
710120048	lewy	121692	10	94 x 48	19	3	25
710120049	prawy	121693	10	94 x 48	19	3	25
710110001	Nożyk	116954	1	96 x 40	19	3	25
710110006	Nożyk	477762	1	96 x 40	19	4	25

Noże do kosiarki rotacyjnej

TYPY NOŻYKÓW

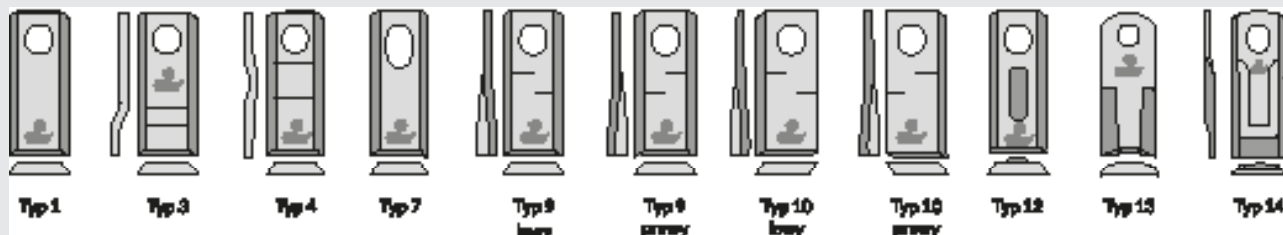

Pasuje do FELLA

NR. AGV	WERSJA	NR. PORÓWNAWCZY	TYP	DŁUGOŚĆ x SZEROKOŚĆ (MM)	Ø OTWORU (MM)	GRUBOŚĆ (MM)	OPAK.
710130001	Nożyki	124243, 478963, 478962	3	96 x 40	19	3	25
710120003	lewy	121712	10	98 x 48	19	4	25
710120004	prawy	121713	10	98 x 48	19	4	25
710120045	prawy	140692	10	102 x 48	19	4	25
710120050	lewy	140693	10	102 x 48	19	4	25
710110007	Nożyk	122331	1	103 x 48	19	4	25
710120023	lewy	122329	10	106 x 48	19	4	25
710120024	prawy	122330	10	106 x 48	19	4	25
710120017	Nożyklewy	135753, 131118, 123706, 134309	10	112 x 48	19	4	25
710120018	prawy	135752, 134308, 131117, 123707	10	112 x 48	19	4	25
710120026	lewy	133075	10	118 x 47	19	4	25
710120025	prawy	1330074	10	118 x 47	19	4	25
710120009	lewy	111724, 478640	10	120 x 48	18,5	4	25
710120010	prawy	111725, 478641	10	120 x 48	18,5	4	25

Pasuje do FORT

NR. AGV	WERSJA	NR. PORÓWNAWCZY	TYP	DŁUGOŚĆ x SZEROKOŚĆ (MM)	Ø OTWORU (MM)	GRUBOŚĆ (MM)	OPAK.
710110011	Nożyk	98D	1	98 x 40	19	3	25
710120082	Nożyk	98P	3	98 x 40	19	3	25
710120015	lewy		9	93 x 40	16,2	3	25
710120016	prawy		9	93 x 40	16,2	3	25
710120174	prawy		10	94 x 48	19	4	25
710120175	lewy		10	94 x 48	9	4	25
710110001	Nożyk		1	96 x 40	19	3	25
710130001	Nożyki		3	96 x 40	19	3	25
710120172	prawy	98DX, 40490005	9	98 x 45	16,5	3,5	25
710120173	lewy	98SX	9	98 x 45	16,5	3,5	25
710130002	Nożyk		4	105 x 46	21	3	25
710120031	lewy	40490006	9	107 x 45	18,2	4	25
710120032	prawy	40490005	9	107 x 45	18,2	4	25
710110010	Nożyk		1	108 x 46	21	3	25
710130006	Nożyk		3	108 x 48	21	3	25
710120022	prawy		10	108 x 48	21	4	25
710120021	lewy		10	108 x 48	21	4	25

Noże do kosiarki rotacyjnej

Pasuje do FORT

NR. AGV	WERSJA	NR. PORÓWNAWCZY	TYP	DŁUGOŚĆ x SZEROKOŚĆ (MM)	Ø OTWORU (MM)	GRUBOŚĆ (MM)	OPAK.
710120010	prawy		10	120 x 48	18,5	4	25
710120009	lewy		10	120 x 48	18,5	4	25

Pasuje do FORTSCHRITT

NR. AGV	WERSJA	NR. PORÓWNAWCZY	TYP	DŁUGOŚĆ x SZEROKOŚĆ (MM)	Ø OTWORU (MM)	GRUBOŚĆ (MM)	OPAK.
710120169	lewy	0300.3350	10	102 x 48	19	4	25
710120170	prawy	0300.3367	10	102 x 48	19	4	25
710120171	gładki	03104179504	1	108 x 48	19	4	25

Pasuje do GALFRÉ

NR. AGV	WERSJA	NR. PORÓWNAWCZY	TYP	DŁUGOŚĆ x SZEROKOŚĆ (MM)	Ø OTWORU (MM)	GRUBOŚĆ (MM)	OPAK.
710110011	Nożyk	98D	1	98 x 40	19	3	25
710110082	Nożyk	98P	3	98 x 40	19	3	25
710110010	Nożyk	108D	1	108 x 46	21	3	25
710120165	lewy		9	108 x 47	21	3	25
710120166	prawy		9	108 x 47	21	3	25
710130006	Nożyk	108P	3	108 x 48	21	3	25
710120183	Nożyk		10	110 x 47	19	3	25
710120168	Nożyk		10	110 x 47	19	3	25

Pasuje do GARNIER

NR. AGV	WERSJA	NR. PORÓWNAWCZY	TYP	DŁUGOŚĆ x SZEROKOŚĆ (MM)	Ø OTWORU (MM)	GRUBOŚĆ (MM)	OPAK.
710120163		4460-404-001	1	88 x 40	22	3	25
710120164		152329	1	117 x 42	18,24	4,5	25

Pasuje do GENERALGARDEN

NR. AGV	WERSJA	NR. PORÓWNAWCZY	TYP	DŁUGOŚĆ x SZEROKOŚĆ (MM)	Ø OTWORU (MM)	GRUBOŚĆ (MM)	OPAK.
710120162	lewy	F05055	10	135 x 40	19	3	25

Pasuje do IHC

NR. AGV	WERSJA	NR. PORÓWNAWCZY	TYP	DŁUGOŚĆ x SZEROKOŚĆ (MM)	Ø OTWORU (MM)	GRUBOŚĆ (MM)	OPAK.
710110005	Nożyki	1133937R1, 3101549R1	1	90 x 40	19	3	25
710120015	lewy	1133939R1, 3160419R1	9	93 x 40	16,2	3	25
710120016	prawy	1133940R1, 3160420R1	9	93 x 40	16,2	3	25
710110001	Nożyk	1133936R1, 3101547R1	1	96 x 40	19	3	25
710130001	Nożyki	1133938R1	3	96 x 40	19	3	25

Noże do kosiarki rotacyjnej

TYPY NOŻYKÓW

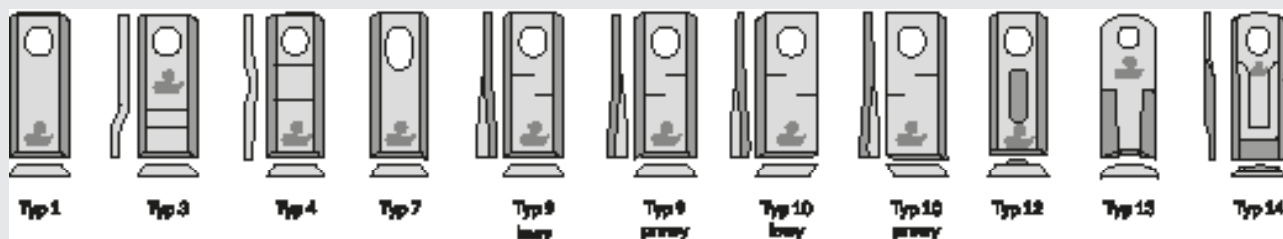

Pasuje do JF-STOLL

NR. AGV	WERSJA	NR. PORÓWNAWCZY	TYP	DŁUGOŚĆ x SZEROKOŚĆ (MM)	Ø OTWORU (MM)	GRUBOŚĆ (MM)	OPAK.
710120161	Nożyk	2220-101A	1	90 x 42	20,5	4	25
71012010	Nożyk	2220-101B	7	90 x 42	20,5 x 24,3	4	25
710120075	lewy	1380-0021, 0676320	10	92,5 x 48	20,5 x 24	4	25
710120076	prawy	1380-0022, 0676330	10	92,5 x 48	20,5 x 24	4	25
710110009	Nożyk	1380-0001, 067630	7	94 x 50	20,5 x 24,3	4	25
710120154	Nożyk	1380-0005	1	96 x 40	19,5	4	25
710120155	lewy	1380-0024, 1115420	10	98 x 48	19	4	25
710120156	prawy	1380-0023, 1115410	10	98 x 48	19	4	25
710120157	Nożyk	1380-0025, 1122100, 1114680	1	97 x 50	19	4	25
71012015	lewy	1380-0031, 1142380	10	109 x 47	19	4	25
71012015	prawy	1380-0032, 1142390	10	109 x 47	19	4	25
710120067	lewy	1380-0015, 1122350	10	112 x 48	19	4	15
710120068	prawy	1380-0014, 1122360	10	112 x 48	19	4	25
710110008	Nożyk	1380-0027, 1138770	1	114 x 50	19	4	25
710130004	sklepiony	1380-0013, 1122330	13	132 x 50	20,5 x 22,8	4	25
710120150	lewy	1380-0028, 1164180	9	134 x 55	21 x 27	4	25
710120151	prawy	1380-0029, 1164190	9	134 x 55	21 x 27	4	25
710120152	lewy	1380-0047, 1195300	10	134 x 55	28 x 21	4	25
710120153	prawy	1380-0046, 1195290	10	134 x 55	28 x 21	4	25

Pasuje do JOHN DEERE

NR. AGV	WERSJA	NR. PORÓWNAWCZY	TYP	DŁUGOŚĆ x SZEROKOŚĆ (MM)	Ø OTWORU (MM)	GRUBOŚĆ (MM)	OPAK.
710120016	prawy	CC19336	9	93 x 40	16,2	3	25
710120015	lewy	CC19333	9	93 x 40	16,2	3	25
710120078	lewy	CC44007, CC20500	9	95 x 45	16,2	3,5	25
710120077	prawy	CC44006, CC20501	9	95 x 45	16,2	3,5	25
710120074	lewy	CC124571	9	105 x 48	20,5	4,3	25
710120073	prawy	CC124572	9	105 x 48	20,5	4,3	25
710120066	lewy	CC23488	9	115 x 45	18,3	4	25
710120065	prawy	CC44002, CC23499	9	115 x 45	19,3	4	25
710120038	lewy	CC44005, CC21780	9	122 x 45	18,2	4	25
710120037	prawy	CC44004, CC21781	9	122 x 45	18,2	4	25
710130007	sklepiony	CC19993	13	130 x 50	18,5 x 20,5	4	25

Noże do kosiarki rotacyjnej

Pasuje do KLAUSING

NR. AGV	WERSJA	NR. PORÓWNAWCZY	TYP	DŁUGOŚĆ x SZEROKOŚĆ (MM)	Ø OTWORU (MM)	GRUBOŚĆ (MM)	OPAK.
710120163		324.01.F22-3	1	88 x 40	22	3	25
710110005		324.01.A22-3	1	90 x 40	19	3	25

Pasuje do KRONE

NR. AGV	WERSJA	NR. PORÓWNAWCZY	TYP	DŁUGOŚĆ x SZEROKOŚĆ (MM)	Ø OTWORU (MM)	GRUBOŚĆ (MM)	OPAK.
710110005	Nożyki	143149.4	1	90 x 40	19	3	25
710120136	lewy	144825.1	10	90 x 50	19	4	25
710120145	prawy	144826.1	10	90 x 50	19	4	25
710120049	prawy	145869.1	10	93 x 47	19	3	25
710120048	prawy	145868.1	10	93 x 47	19	3	25
710120028	lewy	151386.0	10	94 x 48	19	3	25
710120027	prawy	151385.0	10	94 x 48	19	3	25
710120146	lewy	147419.5	10	94 x 40	19	3	25
710120147	prawy	147302.5	10	94 x 40	19	3	25
710110001	Nożyk	143698.0	1	96 x 40	19	3	25
710120001	lewy	146690.2	10	96 x 50	19	4	25
710120002	prawy	146691.2	10	96 x 50	19	4	25
710120148	sklepiony	139400.0	13	96 x 55	19	4	25
710130002	Nożyk	143237.0	4	105 x 45	21	3	25
710120017	lewy	139888.0	10	112 x 48	19	4	25
710120018	prawy	139889.0	10	112 x 48	19	4	25
710120149	sklepiony	139800.0	13	117 x 55	19	4	25

Pasuje do KUHN

NR. AGV	WERSJA	NR. PORÓWNAWCZY	TYP	DŁUGOŚĆ x SZEROKOŚĆ (MM)	Ø OTWORU (MM)	GRUBOŚĆ (MM)	OPAK.
710120143	lewy	56151000	9	87 x 40	16,25	3	25
710120144	prawy	56151100	9	87 x 40	16,25	3	25
710120015	lewy	56151200	9	93 x 40	16,2	3	25
710120016	prawy	56151300	9	93 x 40	16,2	3	25
710120142	Nożyk	56150000	1	94 x 40	16,25	3	25
710120078	lewy	56151210	9	95 x 45	16,2	3,5	25
710120077	prawy	56151310	9	96 x 45	16,2	3,5	25
710120051	lewy, zaokrąglony na głowicy 25 mm	K6802970	9	105 x 47	20,5	4,2	25
710120052	prawy, zaokrąglony na głowicy 25 mm	K6802980	9	105 x 47	20,5	4,2	25
710120074	lewy	K6801410	9	105 x 48	20,5	4,3	25
710120073	prawy	K6801420	9	105 x 48	20,5	4,3	25
710120031	lewy	55903210	9	107 x 45	18,2	4	25
710120032	prawy	55903310	9	107 x 45	18,2	4	25
710130007	sklepiony	56450000, 56840000, 56451600	13	130 x 50	18,5 x 20,5	4	25

Noże do kosiarki rotacyjnej

TYPY NOŻYKÓW

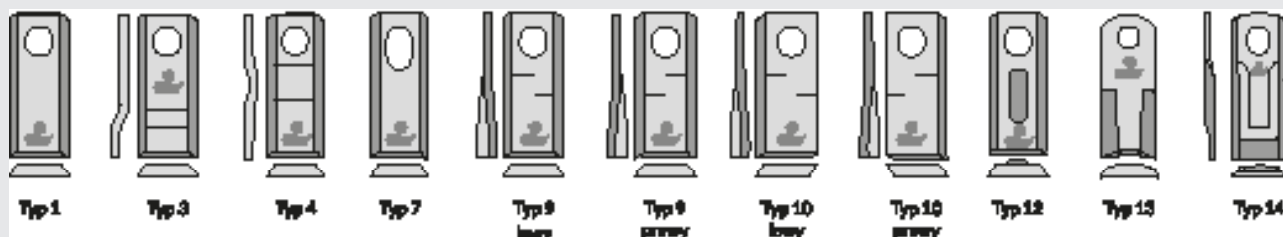

Pasuje do KUHN

NR. AGV	WERSJA	NR. PORÓWNAWCZY	TYP	DŁUGOŚĆ x SZEROKOŚĆ (MM)	Ø OTWORU (MM)	GRUBOŚĆ (MM)	OPAK.
710120066	lewy	55906000	9	115 x 45	18,3	4	25
710120065	prawy	55906100	9	115 x 45	18,3	4	25
710120071	lewy, zaokrąglony na głowicy 25 mm	K6804710	9	116 x 48	20,5	4,3	25
710120072	prawy, zaokrąglony na głowicy 25 mm	K6804720	9	116 x 48	20,5	4,3	1
71012014	Nożyk	56451210	1	123 x 45	18,2	4	25
710120038	lewy	56451200	9	122 x 45	18,2	4	25
710120037	prawy	56451300	9	122 x 45	18,2	4	25
710120013	lewy	5611090001, 56110900	10	126 x 48	20,5 x 23	4	25
710120014	prawy	5611040001, 56110400	10	126 x 48	20,5 x 23	4	25
710130005	sklepiony	5611030001, 56110300	13	128 x 50	20,5 x 22,8	4	25
710130007	sklepiony	56450000, 56840000, 56451600	13	130 x 50	18,5 x 20,5	4	25

Pasuje do KVERNELAND

NR. AGV	WERSJA	NR. PORÓWNAWCZY	TYP	DŁUGOŚĆ x SZEROKOŚĆ (MM)	Ø OTWORU (MM)	GRUBOŚĆ (MM)	OPAK.
710120137	prawy	GM166	10	112 x 47	18,5	4	25
710120138	lewy	GM165	10	112 x 47	18,5	4	25
710120139	sklepiony	B2493602	13	112 x 50	18,5	4	25
710120140	sklepiony	B2493502	13	126 x 50	18,5	4	25

Pasuje do LELY

NR. AGV	WERSJA	NR. PORÓWNAWCZY	TYP	DŁUGOŚĆ x SZEROKOŚĆ (MM)	Ø OTWORU (MM)	GRUBOŚĆ (MM)	OPAK.
710120136	lewy	4.1220.1478.0	10	90 x 50	19	4	25
710120145	prawy	4.1220.1479.0	10	90 x 50	19	4	25
710120009	lewy	4.1201.1473.0, 9.1127.0003.2	10	120 x 48	18,5	4	25
710120010	prawy	4.1201.1474.0, 9.1127.0004.3	10	120 x 48	18,5	4	25

Noże do kosiarki rotacyjnej

Pasuje do MARANGON

NR. AGV	WERSJA	NR. PORÓWNAWCZY	TYP	DŁUGOŚĆ x SZEROKOŚĆ (MM)	Ø OTWORU (MM)	GRUBOŚĆ (MM)	OPAK.
710110011	Nożyk	98D	1	98 x 40	19	3	25
710120134	lewy	100MEL	10	100 x 48	21	4	25
710120135	prawy	100MER	10	100 x 48	21	4	25
710110010	Nożyk	108D	1	108 x 46	21	3	25
710130003	Nożyk	CM120-108	4	108 x 46	21	4	25
710120132	lewy	129 MEL	10	129 x 48	21	4	25
710120133	prawy	129 MER	10	129 x 48	21	4	25

Pasuje do MÖRTL

NR. AGV	WERSJA	NR. PORÓWNAWCZY	TYP	DŁUGOŚĆ x SZEROKOŚĆ (MM)	Ø OTWORU (MM)	GRUBOŚĆ (MM)	OPAK.
710120043	lewy	T-673 L, 025039	10	94 x 48	23	3	25
710120044	prawy	T-673 R, 025040	10	94 x 48	23	3	25
710120130	lewy	T-355-3 L1	9	98 x 47	23	3	25
710120131	prawy	T-655-3 R1	9	98 x 47	23	3	25
710120061	lewy	T-683 L, 028939	10	100 x 48	23	3	25
710120062	prawy	T683 R, 028940	10	100 x 48	23	3	25
710120129	prawy	T-684 R, 031850	10	100 x 48	23	4	25

Pasuje do MORRA

NR. AGV	WERSJA	NR. PORÓWNAWCZY	TYP	DŁUGOŚĆ x SZEROKOŚĆ (MM)	Ø OTWORU (MM)	GRUBOŚĆ (MM)	OPAK.
710110011		98D	1	98 x 40	19	3	25
710110082		98P	3	98 x 40	19	3	25
710110010		108D	1	108 x 46	21	3	25

Pasuje do NEW HOLLAND

NR. AGV	WERSJA	NR. PORÓWNAWCZY	TYP	DŁUGOŚĆ x SZEROKOŚĆ (MM)	Ø OTWORU (MM)	GRUBOŚĆ (MM)	OPAK.
710120015	lewy	274096	9	93 x 40	16,2	3	25
710120016	prawy	274097	9	93 x 40	16,2	3	25
710120142	Nożyk	274230, 549757	1	94 x 40	16,25	3	25
710120078	lewy	766726	9	95 x 45	16,2	3,5	25
710120077	prawy	766727	9	95 x 45	16,2	3,5	25
710120031	lewy	853819	9	107 x 45	18,2	4	25
710120032	prawy	853820	9	107 x 45	18,2	4	25
710120066	Nożyklewy	785608	9	115 x 45	18,3	4	25
710120065	prawy	785609	9	115 x 45	18,3	4	25
710120038	lewy	784220	9	122 x 45	18,2	4	25
710120037	prawy	784221	9	122 x 45	18,2	4	25

Noże do kosiarki rotacyjnej

TYPY NOŻYKÓW

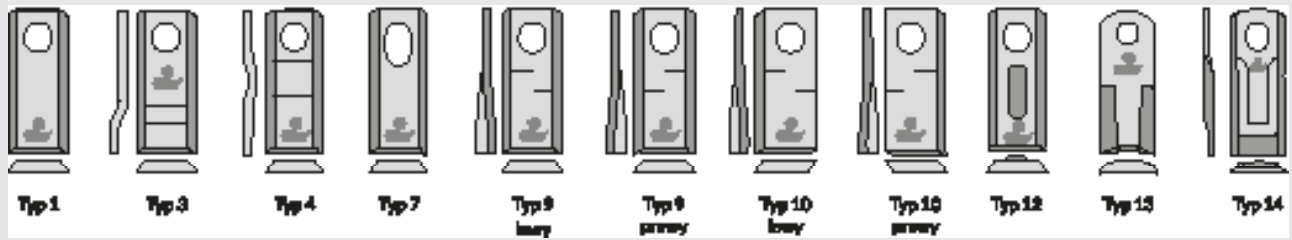

Pasuje do NEW IDEA

NR. AGV	WERSJA	NR. PORÓWNAWCZY	TYP	DŁUGOŚĆ x SZEROKOŚĆ (MM)	Ø OTWORU (MM)	GRUBOŚĆ (MM)	OPAK.
710120125	lewy	526216	10	120 x 48	18,5	4	25
710120126	prawy	526215	10	120 x 48	18,5	4	25
710120127	lewy	527747, 527749	10	120 x 48	22,6	4	25
710120128	prawy	527746, 527748	10	120 x 48	22,6	4	25

Pasuje do NIEMEYER

NR. AGV	WERSJA	NR. PORÓWNAWCZY	TYP	DŁUGOŚĆ x SZEROKOŚĆ (MM)	Ø OTWORU (MM)	GRUBOŚĆ (MM)	OPAK.
710110005	Nożyki	570400, 11065	1	90 x 40	19	3	25
710120048	lewy	570409	10	94 x 48	19	3	25
710120049	prawy	570410	10	94 x 48	19	3	25
710110001	Nożyk	570414	1	96 x 40	19	3	25
710120178	lewy	570411	9	98 x 40	16,2	4,3	25
710120179	prawy	570412	9	98 x 40	16,2	4,3	25
710120036	prawy	570414	10	100 x 48	19	3	25
710120035	lewy	570413	10	100 x 48	19	3	25
710120064	prawy	570418, 570416	10	100 x 50	19	3	25
710120063	lewy	570419, 570417	10	100 x 50	19	3	25
710120079	prawy	570446	10	102 x 48	19	4	25
710120080	lewy	570447	10	102 x 48	19	4	25
710120113	lewy	570437	10	106 x 47	19	3	25
710120114	prawy	570438	10	106 x 47	19	3	25
710120123	lewy	570445	10	106 x 48	19	4	25
710120124	prawy	570444	10	106 x 48	19	4	25
710120057	lewy	570679, 570683	10	107 x 48	19	4	25
710120058	prawy	570680, 570684	10	107 x 48	19	4	25
710120070	prawy	570449	10	120 x 48	21	4	25
710120069	lewy	570448	10	120 x 48	21	4	25
710120121	prawy	570676	10	120 x 48	19	4	25
710120122	lewy	570675	10	120 x 48	19	4	25

Noże do kosiarki rotacyjnej

Pasuje do PÖTTINGER

NR. AGV	WERSJA	NR. PORÓWNAWCZY	TYP	DŁUGOŚĆ x SZEROKOŚĆ (MM)	Ø OTWORU (MM)	GRUBOŚĆ (MM)	OPAK.
710110005	Nożyki	434992	1	90 x 40	19	3	25
710120015	lewy	716060340	9	93 x 40	16,2	3	25
710120016	prawy	716060350	9	93 x 40	16,2	3	25
710120119	lewy	434998, 434996	9	96 x 40	19	3	25
710120120	prawy	434997, 434998	9	96 x 40	19	3	25
710130001	Nożyki	434993	3	96 x 40	19	3	25
710110001	Nożyk	434991	1	96 x 40	19	3	25
710120118	lewy	434980	10	96 x 48	19	3	25
710120012	prawy	434979	10	96 x 48	19	3	25
710110003	Nożyk	434994	1	96 x 50	19	4	25
710120116	lewy	434981	10	98 x 48	19	4	25
710120117	prawy	434982	10	98 x 48	19	4	25
710120035	lewy	434983	10	100 x 48	19	3	25
710120036	prawy	434984	40	100 x 48	19	3	25
710120005	lewy	434973, 434977	10	100 x 48	21	4	25
710120006	prawy	434974, 434978	10	100 x 48	21	4	25
710130002	Nożyk	434120	4	105 x 46	21	3	25
710120115	Nożyk	434987	3	106 x 45	19	4	25
710120055	lewy	434985	10	108 x 47	19	4	25
710120056	prawy	434986	10	108 x 47	19	4	25
710120022	prawy	434972	10	108 x 48	21	4	25
710120021	lewy	434971	10	108 x 48	21	4	25
710120007	lewy	4349690010, 434969	10	112 x 48	21	4	25
710120008	prawy	4349700010, 434970	10	112 x 48	21	4	25
710130008	Nożyk	434122	3	119 x 49	21	4	25
710120009	lewy	434988	10	120 x 48	18,5	4	25
710120010	prawy	434989	10	120 x 48	18,5	4	25
710120070	prawy	434975	10	120 x 48	21	4	25
710120069	lewy	434976	10	120 x 48	21	4	25

Pasuje do PZ (KVERNELAND)

NR. AGV	WERSJA	NR. PORÓWNAWCZY	TYP	DŁUGOŚĆ x SZEROKOŚĆ (MM)	Ø OTWORU (MM)	GRUBOŚĆ (MM)	OPAK.
710110005	Nożyki	MT-52S	1	90 x 40	19	3	25
710120015	lewy	DM-15S	9	93 x 40	16,2	3	25
710120016	prawy	DM-160	9	93 x 40	16,2	3	25
710120041	prawy	TA-321	10	96 x 48	19	4	25
710120042	lewy	TA-322	10	94 x 48	19	3	25
710120028	lewy	TF-71	10	94 x 48	19	3	25
710120027	prawy	Tf-70	10	94 x 48	19	3	25
710110001	Nożyk	MT-452S	1	96 x 40	19	3	25
710130001	Nożyki	TT-97	3	96 x 40	19	3	25
710120178	lewy	DM-303	9	98 x 40	16,2	4,3	25
710120179	prawy	DM-304	9	98 x 40	16,2	4,3	25

Noże do kosiarki rotacyjnej

TYPY NOŻYKÓW

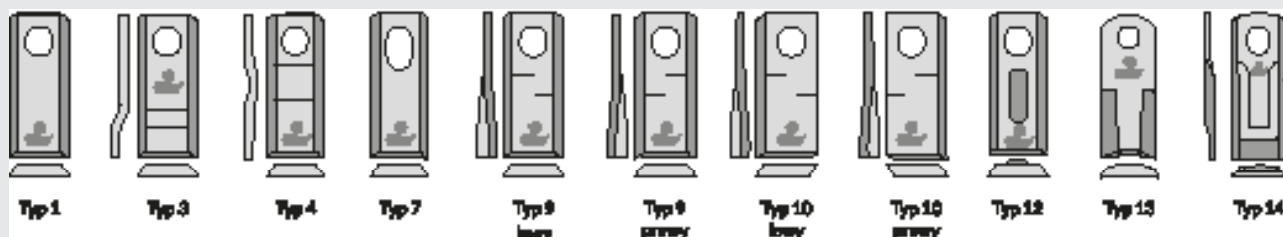

Pasuje do PZ (KVERNELAND)

NR. AGV	WERSJA	NR. PORÓWNAWCZY	TYP	DŁUGOŚĆ x SZEROKOŚĆ (MM)	Ø OTWORU (MM)	GRUBOŚĆ (MM)	OPAK.
710110004	Nożyk	CM-15	1	105 x 46	21	3	25
710130002	Nożyk	CM-120	4	105 x 46	21	3	25
710120111	lewy	B0875102	10	105 x 47	18	4	25
710120112	prawy	B0875002	10	105 x 47	18	4	25
710120113	lewy	DN-383	10	106 x 47	19	3	25
710120114	prawy	DN-382	10	106 x 47	19	3	25
710120054	prawy	CM-138	10	106 x 48	21	3	25
710120053	lewy	CM-137	10	106 x 48	21	3	25
710130003	Nożyk	CM 120-108	4	108 x 46	21	3	25
710120107	lewy	B191980201, B1919802	10	120 x 47	18	4	25
710120108	prawy	B191990201, B1919902	100	120 x 47	18	4	25
710120109	lewy	LG-293	10	120 x 48	18	3	25
710120110	prawy	LG-294	10	120 x 48	18	3	25

Pasuje do PZ RASSPE

NR. AGV	WERSJA	NR. PORÓWNAWCZY	TYP	DŁUGOŚĆ x SZEROKOŚĆ (MM)	Ø OTWORU (MM)	GRUBOŚĆ (MM)	OPAK.
710120105	wzmocniony		12	96 x 40	19	3	25
710120106	Nożyk		1	109 x 40	20,5	3	25

Pasuje do SAMASZ

NR. AGV	WERSJA	NR. PORÓWNAWCZY	TYP	DŁUGOŚĆ x SZEROKOŚĆ (MM)	Ø OTWORU (MM)	GRUBOŚĆ (MM)	OPAK.
710110012	18 nożyków	MINO-000-002	1	96 x 49	19	3	25
710120082	6 lewych, 6 prawych	MINO-000-001	10	98 x 49	19	3	25
710120081	6 lewych, 6 prawych	MINO-000-001	10	98 x 49	19	3	25
710110013	18 nożyków	MINO-000-004	1	102 x 49	19	3	25
710120084	6 lewych, 6 prawych	MINO-100-000	10	100 x 49	21	4	25
710120083	6 lewych, 6 prawych	MINO-100-000	10	100 x 49	21	4	25
710120086	6 lewych, 6 prawych	MINO-000-005	10	105 x 49	19	4	25
710120085	6 lewych, 6 prawych	MINO-000-005	10	105 x 49	19	4	25

Noże do kosiarki rotacyjnej

Pasuje do SAMASZ

NR. AGV	WERSJA	NR. PORÓWNAWCZY	TYP	DŁUGOŚĆ x SZEROKOŚĆ (MM)	Ø OTWORU (MM)	GRUBOŚĆ (MM)	OPAK.
710120087	6 lewych, 6 prawych	MINO-000-006	10	115 x 49	19	4	25
710120088	6 lewych, 6 prawych	MINO-000-006	10	115 x 49	19	4	25
710110001	Nożyk		1	96 x 40	19	3	25
710110007	Nożyk		1	103 x 48	19	4	25
710120030	lewy		10	105 x 48	19	3	25
710120029	prawy		10	105 x 48	19	3	25
710120092	prawy		10	108 x 48	21	3	25
710120091	lewy		10	108 x 48	21	3	25
710120034	lewy		10	115 x 47	19	3	25
710120033	prawy		10	115 x 47	19	4	25
710120090	prawy		10	120 x 49	21	4	25
710120089	lewy		10	120 x 49	21	4	25

Pasuje do SAPHIR

NR. AGV	WERSJA	NR. PORÓWNAWCZY	TYP	DŁUGOŚĆ x SZEROKOŚĆ (MM)	Ø OTWORU (MM)	GRUBOŚĆ (MM)	OPAK.
710110001	Nożyk	5036010454	1	96 x 40	19	3	25
710110007	Nożyk		1	103 x 48	19	4	25
710120030	lewy		10	105 x 48	19	3	25
710120029	prawy		10	105 x 48	19	3	25
710120034	lewy		10	115 x 47	19	4	25
710120033	prawy		10	115 x 47	19	4	25

Pasuje do SIP

NR. AGV	WERSJA	NR. PORÓWNAWCZY	TYP	DŁUGOŚĆ x SZEROKOŚĆ (MM)	Ø OTWORU (MM)	GRUBOŚĆ (MM)	OPAK.
710120102	Nożyk	152147607	1	97 x 47	21	3	25
710120103	lewy	153171311	10	98 x 48	19	4	25
710120104	prawy	153171419	10	98 x 48	19	4	25
710110004	Nożyk	151019702	1	105 x 46	21	3	25
710120100	lewy	153967201	10	106 x 48	19	4	25
710120101	prawy	153967103	10	106 x 48	19	4	25

Pasuje do TAARUP (KVERNELAND)

NR. AGV	WERSJA	NR. PORÓWNAWCZY	TYP	DŁUGOŚĆ x SZEROKOŚĆ (MM)	Ø OTWORU (MM)	GRUBOŚĆ (MM)	OPAK.
710120106	Nożyk	5837200	1	109 x 40	20,5	3	25
710120067	lewy	13800015	10	112 x 48	19	4	25
710120068	prawy	13800014	10	112 x 48	19	4	25
710120013	lewy	5611090001, 56110900	10	126 x 48	20,5 x 23	4	25
710120014	prawy	5611040001, 56110400	10	126 x 48	20,5 x 23	4	25
710130005	sklepiony	5611030001, 56110300	13	128 x 50	20,5 x 22,8	4	25

Noże do kosiarki rotacyjnej

TYPY NOŻYKÓW

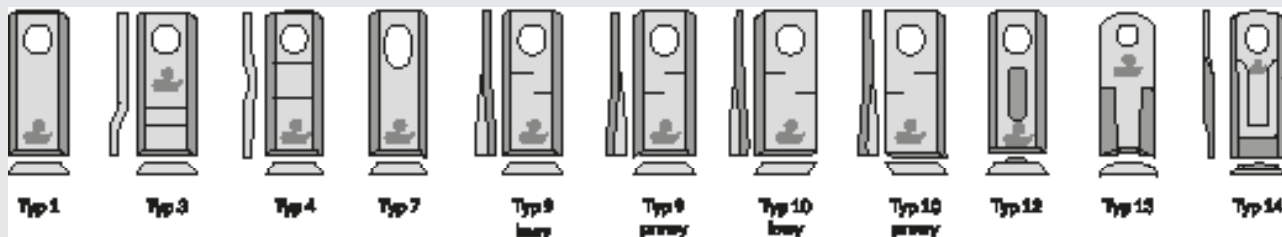

Pasuje do TAARUP (KVERNELAND)

NR. AGV	WERSJA	NR. PORÓWNAWCZY	TYP	DŁUGOŚĆ x SZEROKOŚĆ (MM)	Ø OTWORU (MM)	GRUBOŚĆ (MM)	OPAK.
710120098	sklepiony	56293100, 56110500	14	131 x 50	20,5 x 23	4	25
710120099	sklepiony	16530208	13	132 x 50	20,5 x 22,8	4	

Pasuje do VICON (KVERNELAND)

NR. AGV	WERSJA	NR. PORÓWNAWCZY	TYP	DŁUGOŚĆ x SZEROKOŚĆ (MM)	Ø OTWORU (MM)	GRUBOŚĆ (MM)	OPAK.
710120041	prawy	TA321	10	96 x 48	19	4	25
710120042	lewy	TA321	10	96 x 48	19	4	25
710120028	lewy	TF-71, 4189400001	10	94 x 48	19	3	25
710120027	prawy	TF-70, 4188300001	10	94 x 48	19	3	25
710130002	Nożyk	CM-120, 4189900001	4	105 x 46	21	3	25
710120096	Nożyk	XD-570	1	105 x 50	18	4	25
710120019	lewy	902.61.559	10	107 x 48	18,5	4	25
710120020	prawy	902.61.560	10	107 x 48	18,5	4	25
710120009	lewy	VN9935869901, VN99358699	10	120 x 48	18,5	4	25
710120010	prawy	VN9935870001, VN99358700	10	120 x 48	18,5	4	25

Pasuje do WELGER

NR. AGV	WERSJA	NR. PORÓWNAWCZY	TYP	DŁUGOŚĆ x SZEROKOŚĆ (MM)	Ø OTWORU (MM)	GRUBOŚĆ (MM)	OPAK.
710110005	Nożyki	0982150100	1	90 x 40	19	3	25
710120095	lewy	0982150800	10	90 x 40	19	3	25
710120096	prawy	098215090	10	90 x 40	19	3	25
710110001	Nożyk	0982150600	1	96 x 40	19	3	25
710120070	prawy	3292050125, 0982151600	10	120 x 48	21	4	25
710120069	lewy	3292050225, 0982151700	10	120 x 48	21	4	25

02

Noże do sieczkarni

21-39

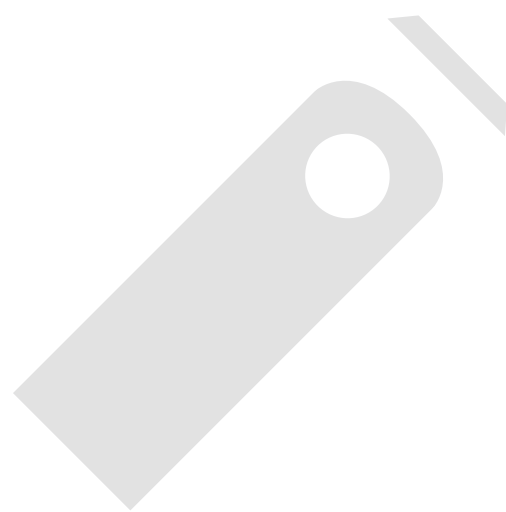

Noże do sieczkarni

Pasuje do BIZON

NR. AGV	OPIS	ZASTOSOWANIE
610190018	Nóż sieczkarni gładki ruchomy	Bizon: OEM: 5110700010

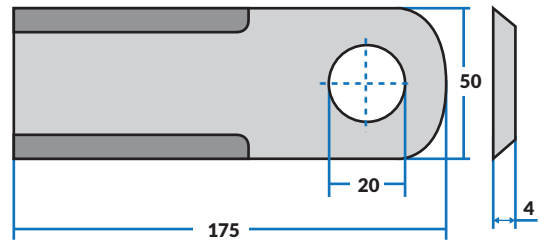

NR. AGV	OPIS	ZASTOSOWANIE
610190019	Nóż sieczkarni gładki stały (x1)	Bizon: OEM: 5110700170

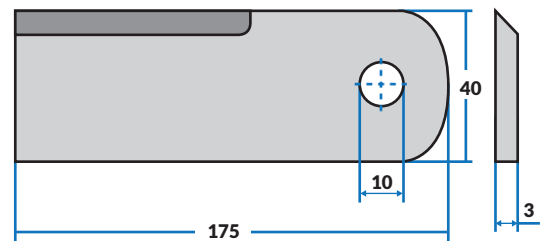

Pasuje do BIZON - RECORD

NR. AGV	OPIS	ZASTOSOWANIE
610190014	Nóż sieczkarni gładki (x1)	Bizon-Record: OEM: HF40150

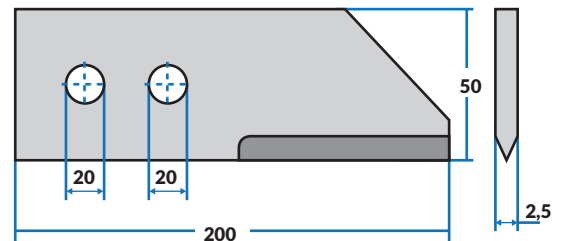

Pasuje do CASE - IH

NR. AGV	OPIS	ZASTOSOWANIE
610190007	Nóż sieczkarni gładki (x1)	Case-IH: 1660, 2166, 2188, 2365, 2366, 2377, 2388, AFX8010 OEM: 1322233C2

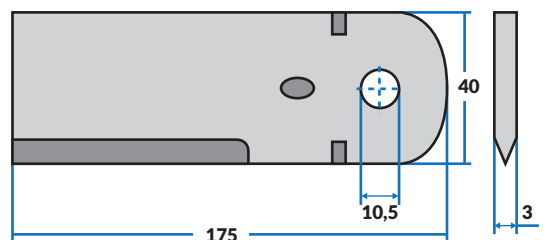

NR. AGV	OPIS	ZASTOSOWANIE
610190008	Nóż sieczkarni gładki (x2)	Case-IH: 1620, 1640, 1640E, 1660, 1660E, 1680, 1680E OEM: 1322241C2

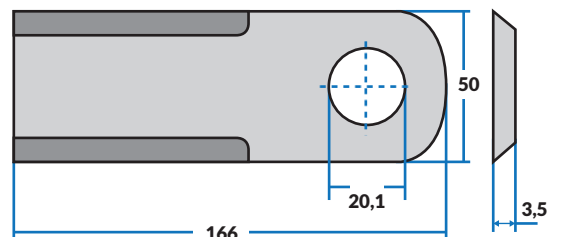

Pasuje do CASE - IH

NR. AGV	OPIS	ZASTOSOWANIE
---------	------	--------------

610190012	Nóż sieczkarni zębaty (x2)	Case-IH: CF 60, 70, 80 OEM: 84437624
-----------	----------------------------	---

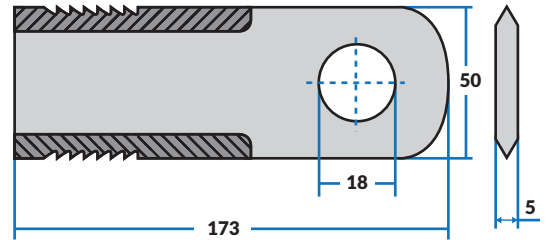

NR. AGV	OPIS	ZASTOSOWANIE
---------	------	--------------

610190024	Nóż sieczkarni zębaty z tulejką (x2)	Case-IH: 1640E, 1660, 1680, 2166, 2188, 2365, 2366, 2377, 2388 OEM: 1994760C4R
-----------	--------------------------------------	---

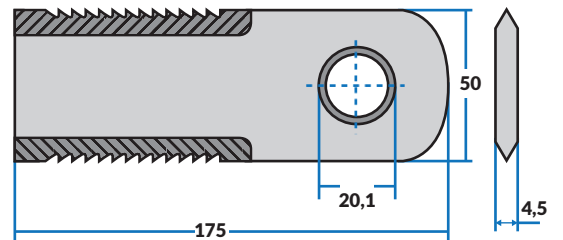

NR. AGV	OPIS	ZASTOSOWANIE
---------	------	--------------

610190025	Nóż sieczkarni gładki	Case-IH: 2166, 2188, 2365, 2366, 2377, 2388 OEM: 1994760C4
-----------	-----------------------	---

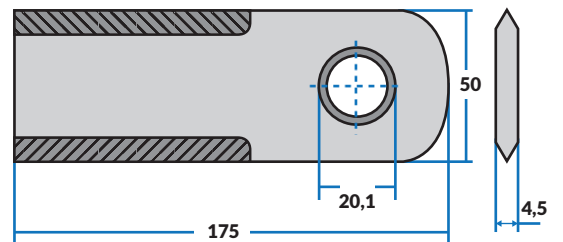

NR. AGV	OPIS	ZASTOSOWANIE
---------	------	--------------

610190027	Nóż sieczkarni zębaty (x1)	Case-IH: CT 5050, 5060, 5070, 5080 OEM: 322291650
-----------	----------------------------	--

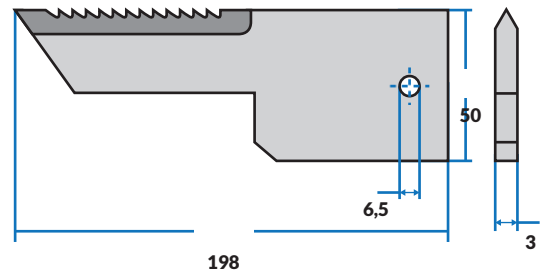

NR. AGV	OPIS	ZASTOSOWANIE
---------	------	--------------

610190038	Nóż sieczkarni gładki	Case-IH: 1620, 1640, 1640E, 1660, 1660E, 1680, 1680E, 2166, 2188, 2365, 2366, 2377, 2388 OEM: HF40151
-----------	-----------------------	--

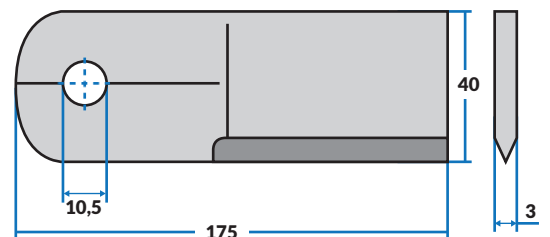

Noże do siewczkarni

Pasuje do CLASS

NR. AGV	OPIS	ZASTOSOWANIE
610190001	Nóż siewczkarni gładki 3 mm (x2)	Claas: Avero 160, 240, Commandor 114, 115, 228, 116, Dominator 86, 106, 108, 118, 128, 130, 150, 38, 48, 58, 68, 76, 78, 88, 96, 98, Medion 330, 310, 340, Mega 202, 204, 203, 208, 218, 350, 360, 370
OEM: 060017.3MM		

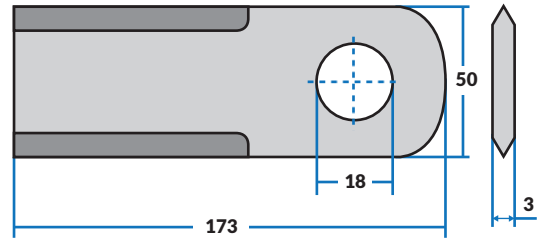

NR. AGV	OPIS	ZASTOSOWANIE
610190002	Nóż siewczkarni gładki 4 mm (x2)	Claas: Avero 160, 240, Commandor 114, 115, 228, 116, Dominator 86, 106, 108, 118, 128, 130, 150, 38, 48, 58, 68, 76, 78, 88, 96, 98, Medion 330, 310, 340, Mega 202, 204, 203, 208, 218, 350, 360, 370
OEM: 060017.4MM		

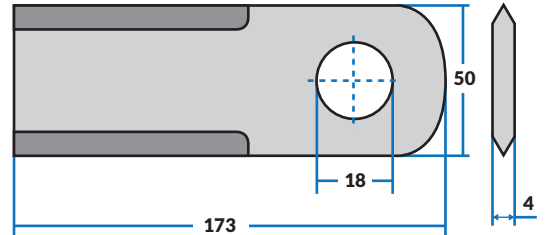

NR. AGV	OPIS	ZASTOSOWANIE
610190003	Nóż siewczkarni zębaty (x2)	Claas: Avero 160, 240, Commandor 114, 115, 228, 116, Dominator 86, 106, 108, 118, 128, 130, 150, 38, 48, 58, 68, 76, 78, 88, 96, 98, Medion 330, 310, 340, Mega 202, 204, 203, 208, 218, 350, 360, 370
OEM: 060017.4MM.Z		

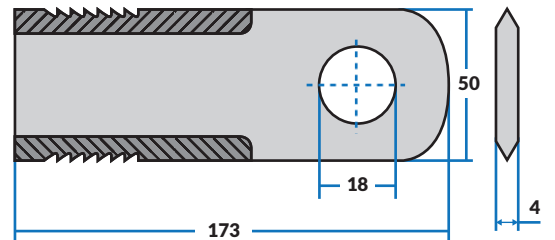

NR. AGV	OPIS	ZASTOSOWANIE
610190004	Nóż siewczkarni gładki (x2)	Claas: Avero 160, 240, Commandor 114, 115, 228, 116, Dominator 106, 108, 118, 128, 130, 150, 38, 48, 58, 68, 76, 78, 86, 88, 96, 98, Lexion 410, 405, 430, 415, 420, 450, 460, 440, 465, 470, 475, 480, 485, 510, 530, 520, 560, 540, 570, 580, 600, 630, 620, 670, 750, 730, 740, 760, 770, 780, Medion 330, 310, 340, Mega 202, 204, 203, 218, 208, 350, 370, 360, Tucano 320, 330, 340, 430, 420, 440, 450, 470, 480, 570, 580
OEM: 060030		

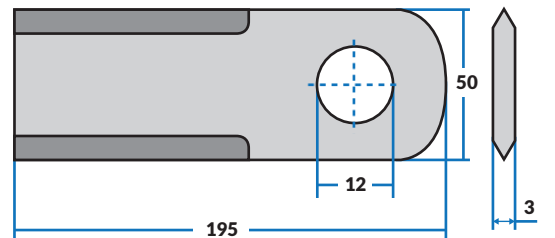

NR. AGV	OPIS	ZASTOSOWANIE
610190005	Nóż siewczkarni zębaty (x2)	Claas: Avero 160, 240, Commandor 114, 115, 228, 116, Dominator 106, 108, 118, 128, 130, 150, 38, 48, 58, 68, 76, 78, 86, 88, 96, 98, Lexion 410, 405, 430, 415, 420, 450, 460, 440, 465, 470, 475, 480, 485, 510, 530, 520, 560, 540, 570, 580, 600, 630, 620, 670, 750, 730, 740, 760, 770, 780, Medion 330, 310, 340, Mega 202, 204, 203, 218, 208, 350, 370, 360, Tucano 320, 330, 340, 430, 420, 440, 450, 470, 480, 570, 580
OEM: 060030.Z		

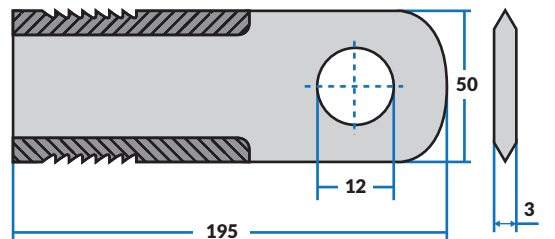

Pasuje do CLASS

NR. AGV	OPIS	ZASTOSOWANIE
610190006	Nóż sieczkarni zębaty (x2)	Claas: Medion 340, Mega 208, 218, Dominator 118, 108, 98, 88, 78, Commandor 228, 114, 115, 112 OEM: 065294

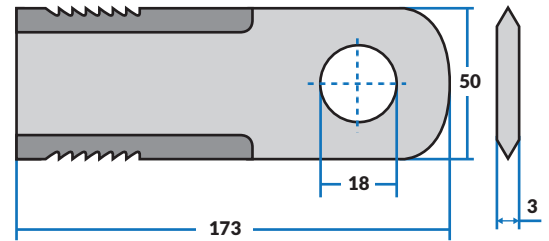

NR. AGV	OPIS	ZASTOSOWANIE
610190009	Nóż sieczkarni gładki (x2)	Claas: Lexion 410, 405, 415, 430, 440, 460, 470, 450, 560, 550, 570, 530, 520, 510, 580, 600, Tucano 330, 320, 340, 430, 440, 450 OEM: 736872

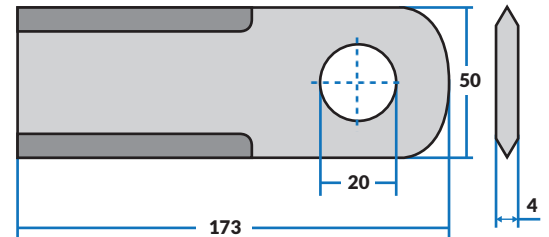

NR. AGV	OPIS	ZASTOSOWANIE
610190010	Nóż sieczkarni gładki z tulejką (x2)	Claas: Lexion 600, 580, 480, 470 OEM: 755874

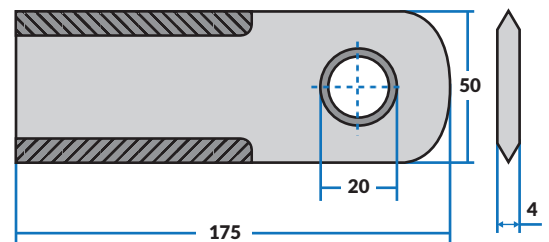

NR. AGV	OPIS	ZASTOSOWANIE
610190011	Nóż sieczkarni zębaty z tulejką (x2)	Claas: LEXION 580, 480, 470 OEM: 755875

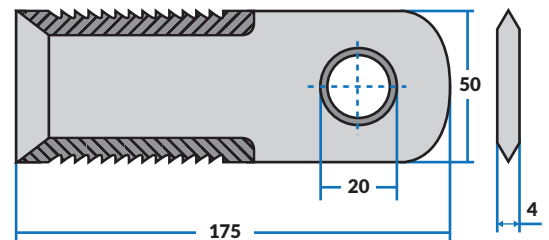

NR. AGV	OPIS	ZASTOSOWANIE
610190034	Nóż sieczkarni zębaty	Claas: Lexion 410, 405, 415, 430, 440, 450, 460 OEM: 755784

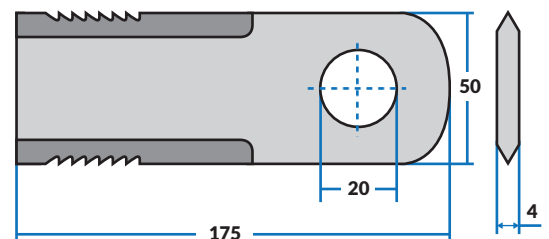

Noże do siewczarni

Pasuje do CLASS

NR. AGV	OPIS	ZASTOSOWANIE
610190036	Nóż siewczarni gładki	Claas: Avero 160, 240, Commandor 228, 116, Dominator 118, 108, 128, 130, 88, 98, Lexion 410, 405, 430, 415, 420, 440, 460, 450, 470, 475, 480, 510, 520, 530, 540, 550, 560, 570, 580, 600, 630, 620, 640, 670, 750, 730, 740, 760, 770, 780, Medion 310, 330, 340, Mega 204, 203, 208, 218, 350, 370, 360, Tucano 320, 330, 340, 430, 420, 450, 440, 580, 570

OEM: 065641

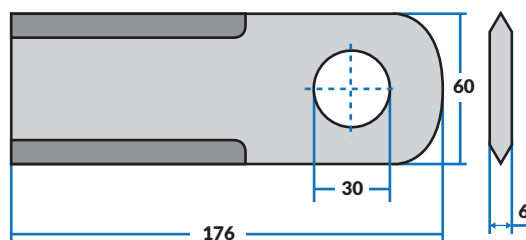

NR. AGV	OPIS	ZASTOSOWANIE
610190037	Nóż siewczarni gładki	Claas: Lexion 480

OEM: 755874

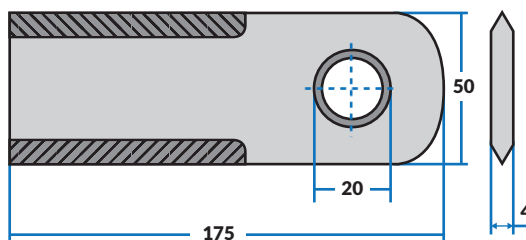

Pasuje do JOHN DEERE

NR. AGV	OPIS	ZASTOSOWANIE
610190001	Nóż siewczarni gładki (x2)	John Deere: 2254, 2256, 2258, 2264, 2266, 9540, 9560, 9580, 9780 CTS, Seria 902, 905, 1000, 1100, 2054, 2056, 2058, 2064, 2066, 1170, 1450, 1450CWS, 1550, 1550CWS, Seria 1100

OEM: Z53454

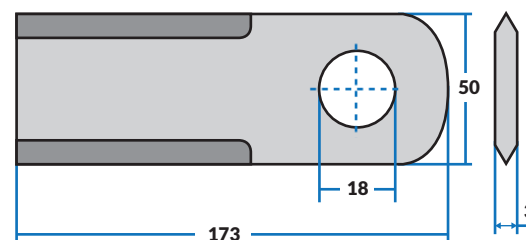

NR. AGV	OPIS	ZASTOSOWANIE
610190002	Nóż siewczarni gładki (x2)	John Deere: 2254, 2256, 2258, 2264, 2266, 9540, 9560, 9580, 9780 CTS, Seria 902, 905, 1000, 1100, 2054, 2056, 2058, 2064, 2066, 1170, 1450, 1450CWS, 1550, 1550CWS, Seria 1100

OEM: Z48237

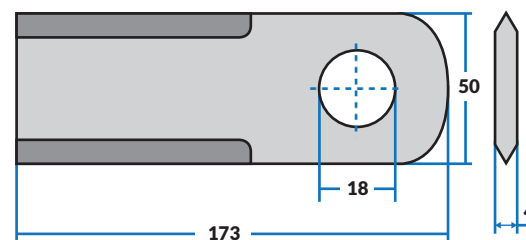

NR. AGV	OPIS	ZASTOSOWANIE
610190003	Nóż siewczarni zębaty (x2)	John Deere: 2254, 2256, 2258, 2264, 2266, 9540, 9560, 9580, 9780 CTS, Seria 902, 905, 1000, 1100, 2054, 2056, 2058, 2064, 2066, 1170, 1450, 1450CWS, 1550, 1550CWS, Seria 1100

OEM:

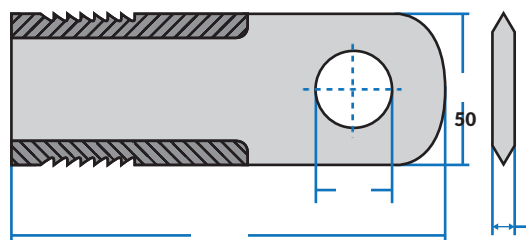

Pasuje do JOHN DEERE

NR. AGV	OPIS	ZASTOSOWANIE
610190004	Nóż sieczkarni gładki (x2)	John Deere: 2254, 2256, 2258, 2264, 2266, 9540, 9560, 9580, 9780 CTS, Seria 902, 905, 1000, 1100
		OEM: Z59020

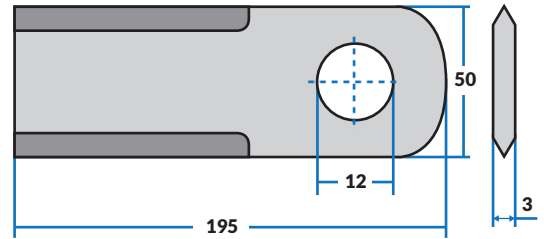

NR. AGV	OPIS	ZASTOSOWANIE
610190005	Nóż sieczkarni zębaty (x2)	John Deere: 2254, 2256, 2258, 2264, 2266, 9540, 9560, 9580, 9780 CTS, Seria 902, 905, 1000, 1100
		OEM: Z77601

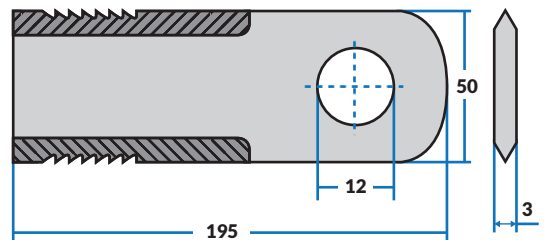

NR. AGV	OPIS	ZASTOSOWANIE
610190016	Nóż sieczkarni gładki z uskokiem (x1)	John Deere: 2054, 2056, 2058, 2064, 2066, 9780 CTS, 9540, 9560, 9580, 9640, 9660, 9680
		OEM: Z59020

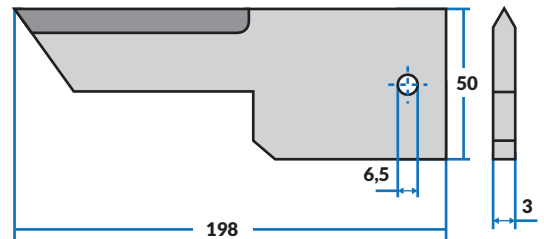

NR. AGV	OPIS	ZASTOSOWANIE
610190017	Nóż sieczkarni zębaty z uskokiem (x1)	John Deere: 2054, 2056, 2058, 2064, 2066, 2254, 2256, 2258, 2264, 2266
		OEM: Z59033

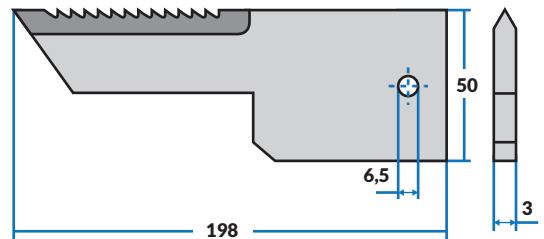

NR. AGV	OPIS	ZASTOSOWANIE
610190026	Nóż sieczkarni gładki	John Deere: Seria 902, 905, 1000
		OEM: Z42176

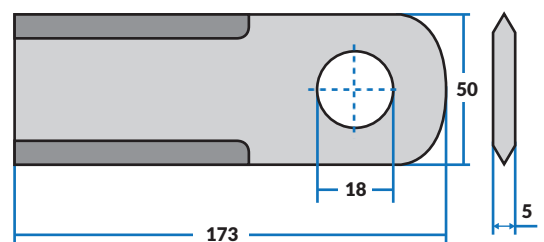

Noże do sieczkarni

Pasuje do JOHN DEERE

NR. AGV	OPIS	ZASTOSOWANIE
610190032	Nóż sieczkarni	John Deere: 9500, 9500SH, 9600, 9510, 9510SH, 9750, 9650STS, 9750STS, CTS, CTS II OEM: AH205910

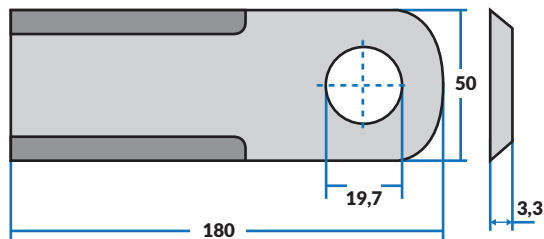

NR. AGV	OPIS	ZASTOSOWANIE
610190033	Nóż sieczkarni zębaty (x3)	John Deere: 2054, 2064, 2254, 2264, 2056, 2058, 2066, 2256, 2258, 2266 OEM: Z55610

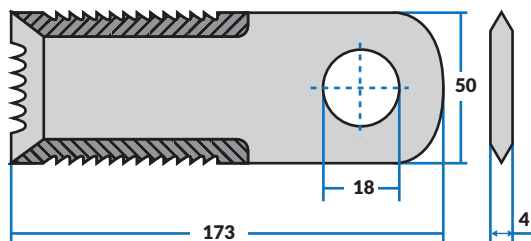

NR. AGV	OPIS	ZASTOSOWANIE
610190039	Nóż sieczkarni zębaty	John Deere: Seria 1100 OEM: Z55611

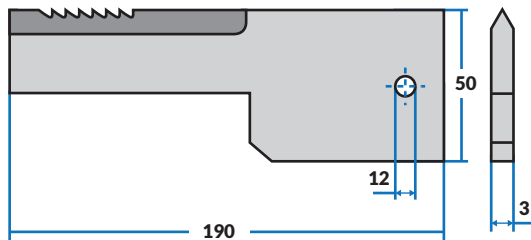

NR. AGV	OPIS	ZASTOSOWANIE
610190031/P	Nóż sieczkarni wygięty prawy (x1)	John Deere: 9500, 9500SH, 9600, 9510, 9510SH, 9750, 9650STS, 9750STS, CTS, CTS II OEM: AH205909/P

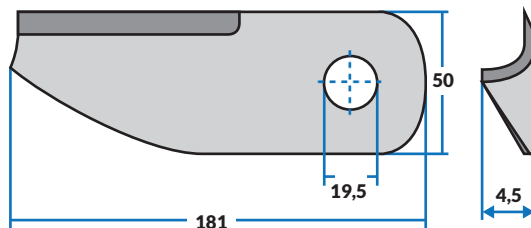

NR. AGV	OPIS	ZASTOSOWANIE
610190031/L	Nóż sieczkarni wygięty lewy (x1)	John Deere: 9500, 9500SH, 9600, 9510, 9510SH, 9750, 9650STS, 9750STS, CTS, CTS II OEM: AH205909/L

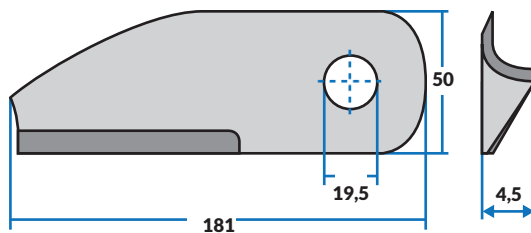

Pasuje do JOHN DEERE

NR. AGV	OPIS	ZASTOSOWANIE
610190001	Nóż sieczkarni gładki (x2)	John Deere: 2254, 2256, 2258, 2264, 2266, 9540, 9560, 9580, 9780 CTS, Seria 902, 905, 1000, 1100, 2054, 2056, 2058, 2064, 2066, 1170, 1450, 1450CWS, 1550, 1550CWS, Seria 1100 OEM: Z35221

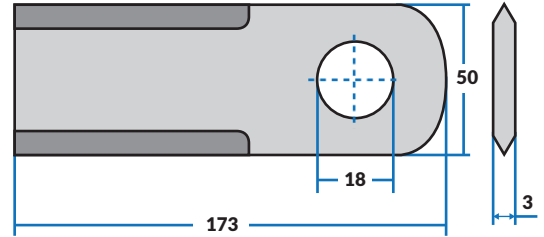

NR. AGV	OPIS	ZASTOSOWANIE
610190002	Nóż sieczkarni gładki (x2)	John Deere: 2254, 2256, 2258, 2264, 2266, 9540, 9560, 9580, 9780 CTS, Seria 902, 905, 1000, 1100, 2054, 2056, 2058, 2064, 2066, 1170, 1450, 1450CWS, 1550, 1550CWS, Seria 1100 OEM: Z53454

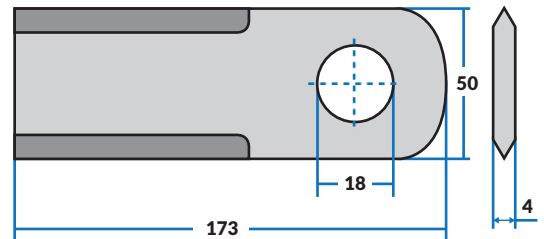

NR. AGV	OPIS	ZASTOSOWANIE
610190003	Nóż sieczkarni zębaty (x2)	John Deere: 2254, 2256, 2258, 2264, 2266, 9540, 9560, 9580, 9780 CTS, Seria 902, 905, 1000, 1100, 2054, 2056, 2058, 2064, 2066, 1170, 1450, 1450CWS, 1550, 1550CWS, Seria 1100 OEM:

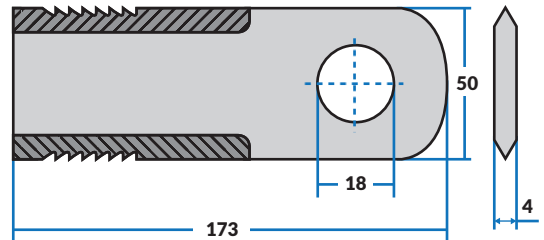

NR. AGV	OPIS	ZASTOSOWANIE
610190004	Nóż sieczkarni gładki (x2)	John Deere: 2254, 2256, 2258, 2264, 2266, 9540, 9560, 9580, 9780 CTS, Seria 902, 905, 1000, 1100 OEM: Z35241

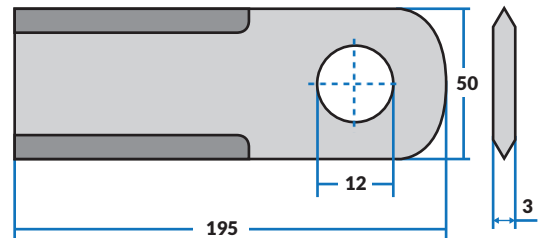

NR. AGV	OPIS	ZASTOSOWANIE
610190005	Nóż sieczkarni zębaty (x2)	John Deere: 2254, 2256, 2258, 2264, 2266, 9540, 9560, 9580, 9780 CTS, Seria 902, 905, 1000, 1100 OEM: Z35241

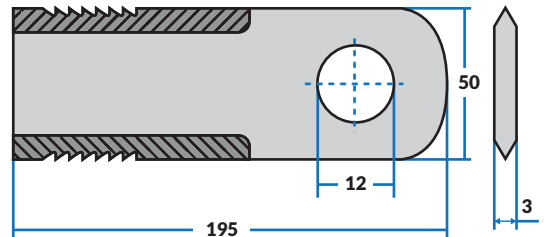

Noże do siewczkarni

Pasuje do LAVERDA

NR. AGV	OPIS	ZASTOSOWANIE
610190001	Nóż siewczkarni gładki (x2)	Laverda: L411, L413, L416, L516 OEM: 3605-0566

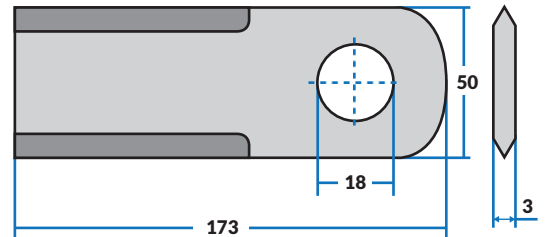

NR. AGV	OPIS	ZASTOSOWANIE
610190002	Nóż siewczkarni gładki (x2)	Laverda: L411, L413, L416, L516 OEM: 320706150

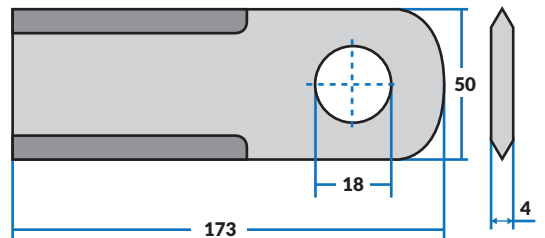

NR. AGV	OPIS	ZASTOSOWANIE
610190015	Nóż siewczkarni zębaty (x3)	Laverda: AL 519 OEM:

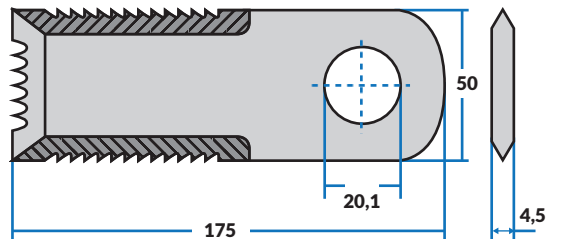

NR. AGV	OPIS	ZASTOSOWANIE
610190016	Nóż siewczkarni gładki z uskokiem (x1)	Laverda: L411, L413, L416, L516, AL519 OEM: 322235550

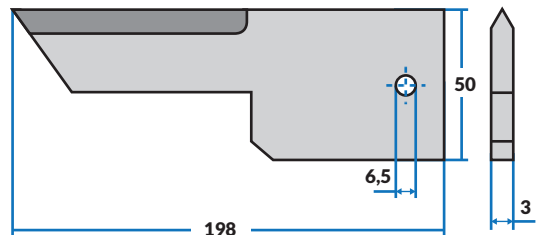

NR. AGV	OPIS	ZASTOSOWANIE
610190017	Nóż siewczkarni zębaty z uskokiem (x1)	Laverda: L411, L413, L416, L516, AL519 OEM: 322291650

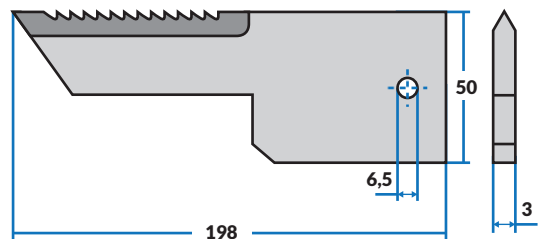

Pasuje do LAVERDA

NR. AGV	OPIS	ZASTOSOWANIE
610190027	Nóż sieczkarni zębaty z uskokiem (x1)	Laverda: AL519, L411, L413, L416, L516, L517, L518, L520, L521, L523, L524, L525, L624, L625, L626, L627
		OEM: 322291650

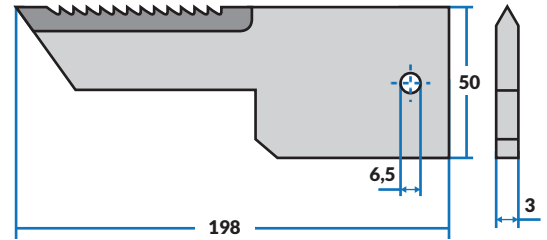

NR. AGV	OPIS	ZASTOSOWANIE
610190033	Nóż sieczkarni zębaty (x3)	Laverda: L517, L518, L520, L521, L523, L524, L525, L624, L625, L626, L627
		OEM: 322326450

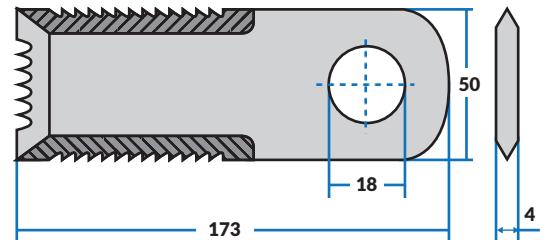

NR. AGV	OPIS	ZASTOSOWANIE
610190001	Nóż sieczkarni gładki (x2)	Laverda: L411, L413, L416, L516
		OEM: 3605-060017.0

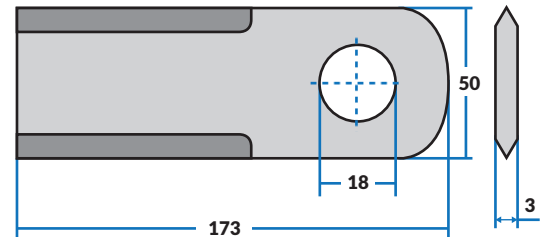

NR. AGV	OPIS	ZASTOSOWANIE
610190002	Nóż sieczkarni gładki (x2)	Laverda: L411, L413, L416, L516
		OEM:

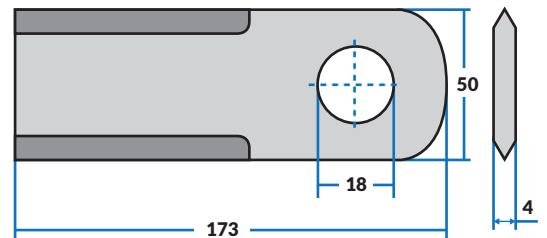

Pasuje do MASSEY FERGUSON

NR. AGV	OPIS	ZASTOSOWANIE
610190001	Nóż sieczkarni gładki (x2)	Massey Ferguson: 118, 520, 530, 535, 560, 565, 620, 660, 665, 750, 760
		OEM: D49018900

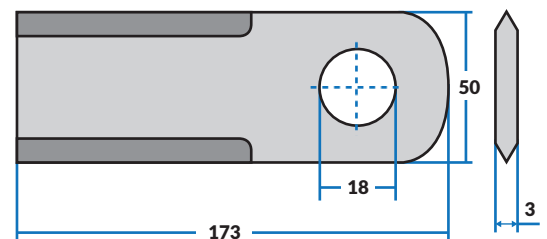

Noże do siewczarni

Pasuje do MASSEY FERGUSON

NR. AGV	OPIS	ZASTOSOWANIE
610190002	Nóż siewczarni gładki (x2)	Massey Ferguson: 118, 520, 530, 535, 560, 565, 620, 660, 665, 750, 760 OEM: D49017800

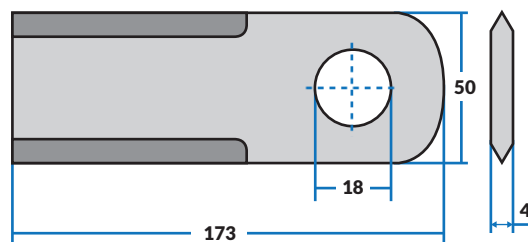

NR. AGV	OPIS	ZASTOSOWANIE
610190003	Nóż siewczarni zębaty (x2)	Massey Ferguson: 118, 520, 530, 535, 560, 565, 620, 660, 665, 750, 760 OEM:

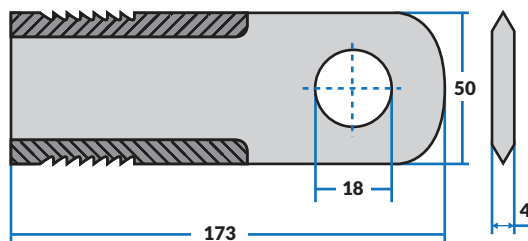

NR. AGV	OPIS	ZASTOSOWANIE
610190004	Nóż siewczarni gładki (x2)	Massey Ferguson: 118, 520, 530, 535, 560, 565, 620, 660, 665, 750, 760 OEM:

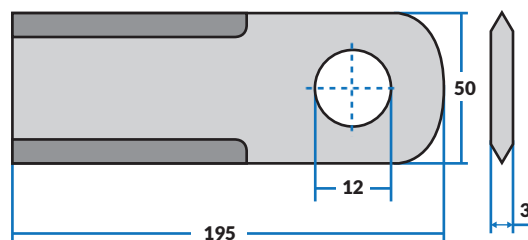

NR. AGV	OPIS	ZASTOSOWANIE
610190005	Nóż siewczarni zębaty (x2)	Massey Ferguson: 118, 520, 530, 535, 560, 565, 620, 660, 665, 750, 760 OEM:

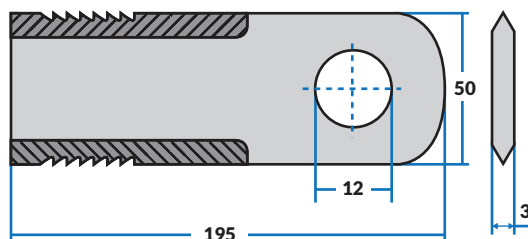

NR. AGV	OPIS	ZASTOSOWANIE
610190023	Nóż siewczarni (x2)	Massey Ferguson: 118, 520, 530, 535, 560, 565, 620, 660, 665, 750, 760 OEM: 1730717M2

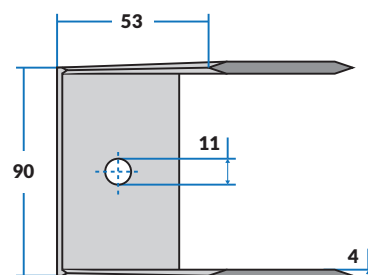

Pasuje do MASSEY FERGUSON

NR. AGV	OPIS	ZASTOSOWANIE
---------	------	--------------

610190038	Nóż sieczkarni	Massey Ferguson: OEM: D49080066
-----------	----------------	--

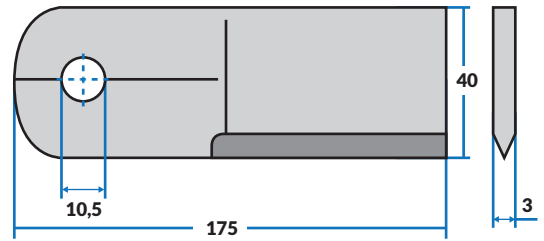

NR. AGV	OPIS	ZASTOSOWANIE
---------	------	--------------

610190001	Nóż sieczkarni gładki (x2)	Massey Ferguson: 118, 520, 530, 535, 560, 565, 620, 660, 665, 750, 760 OEM: 3605-060017M1
-----------	----------------------------	--

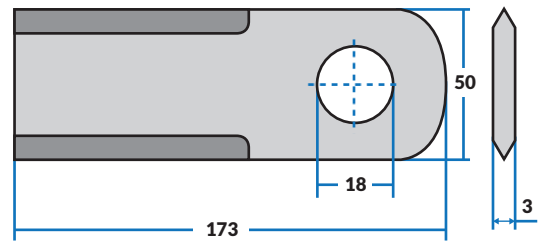

NR. AGV	OPIS	ZASTOSOWANIE
---------	------	--------------

610190002	Nóż sieczkarni gładki (x2)	Massey Ferguson: 118, 520, 530, 535, 560, 565, 620, 660, 665, 750, 760 OEM: 1730728M2
-----------	----------------------------	--

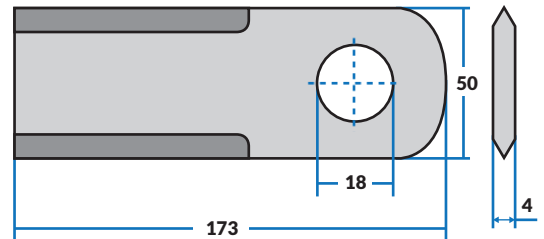

NR. AGV	OPIS	ZASTOSOWANIE
---------	------	--------------

610190003	Nóż sieczkarni zębaty (x2)	Massey Ferguson: 118, 520, 530, 535, 560, 565, 620, 660, 665, 750, 760 OEM:
-----------	----------------------------	--

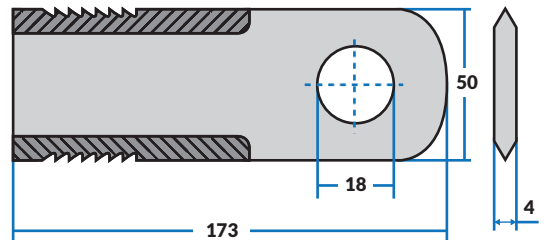

NR. AGV	OPIS	ZASTOSOWANIE
---------	------	--------------

610190004	Nóż sieczkarni gładki (x2)	Massey Ferguson: 118, 520, 530, 535, 560, 565, 620, 660, 665, 750, 760 OEM: D49019000
-----------	----------------------------	--

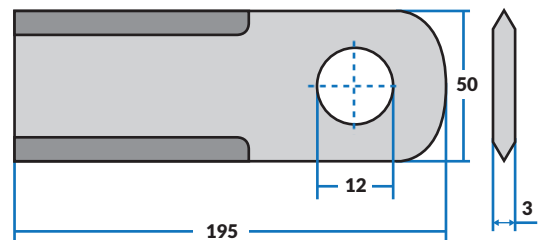

Noże do siewczarni

Pasuje do MASSEY FERGUSON

NR. AGV	OPIS	ZASTOSOWANIE
610190005	Nóż siewczarni zębaty (x2)	Massey Ferguson: 118, 520, 530, 535, 560, 565, 620, 660, 665, 750, 760
		OEM:

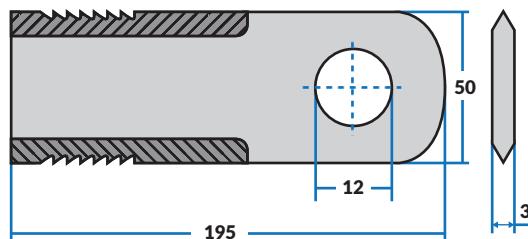

Pasuje do NEW HOLLAND

NR. AGV	OPIS	ZASTOSOWANIE
610190001	Nóż siewczarni gładki (x2)	New Holland: TX 30, 32, 34, 36
		OEM: 80746812

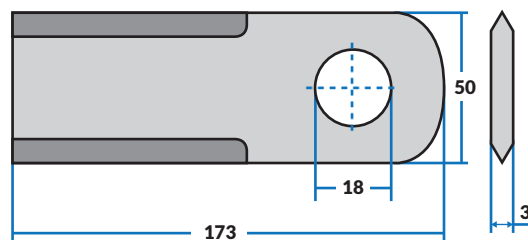

NR. AGV	OPIS	ZASTOSOWANIE
610190002	Nóż siewczarni gładki (x2)	New Holland: TX 30, 32, 34, 36
		OEM: 80743557

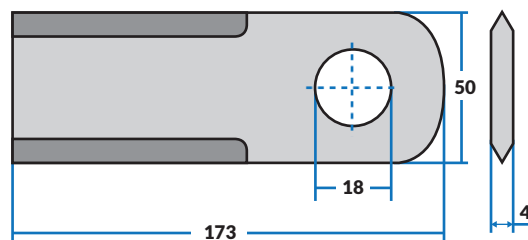

NR. AGV	OPIS	ZASTOSOWANIE
610190012	Nóż siewczarni zębaty (x2)	New Holland: CR 9080, 960, 980, CX 720, 740, 760, 780, 820, 840, 860, 880
		OEM: 84437624

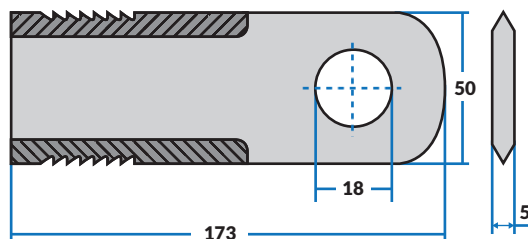

NR. AGV	OPIS	ZASTOSOWANIE
610190013	Nóż siewczarni zębaty (x2)	New Holland: CR 9060, 9070, 9080, 9090, 960, 980, CX 70, 720, 740, 760, 780, 8030, 8040, 8050, 8060, 8070, 8080, 8090, 820, 840, 860, 880,
		OEM: 87318316

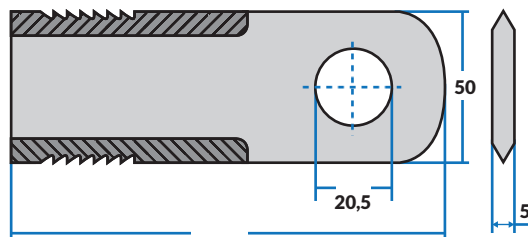

Pasuje do NEW HOLLAND

NR. AGV	OPIS	ZASTOSOWANIE
610190015	Nóż sieczkarni zębaty (x3)	New Holland: CL 6060, CS 6050, 6060, 6060H, 6070, 6080, 6090, CSX 7040, 7050, 7050H, 7060, 7070, 7080, TC 5050, 5060, 5070, 5080, 5080H, TC 54, 56, AL59
		OEM: 84068444

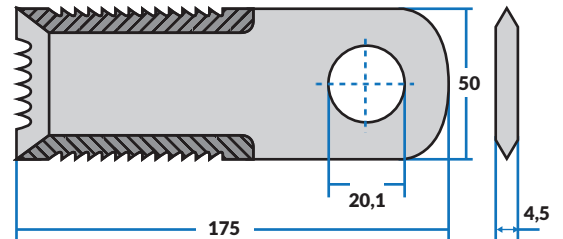

NR. AGV	OPIS	ZASTOSOWANIE
610190016	Nóż sieczkarni gładki z uskokiem (x1)	New Holland: 8030, 8040, 8050, 8055, 8060, 8070, 8080, AL 59, CL 560, 6060, CS 520, 540, 6050, 6060, 6060H, 6070, 6080, 6090, 640, 660, CSX 7040, 7050, 7050H, 7060, 7070, 7080, TC 52, 54, 56, TX 30, 32, 34, 36, TF 76, 78
		OEM: 80746805

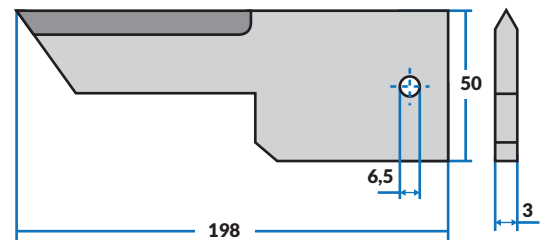

NR. AGV	OPIS	ZASTOSOWANIE
610190017	Nóż sieczkarni zębaty z uskokiem (x1)	New Holland: AL 59, CL 560, 6060, CS 520, 540, 6050, 6060, 6060H, 6070, 6080, 6090, 640, 660, CSX 7040, 7050, 7050H, 7060, 7070, 7080, TC 52, 54, 56, TX 30, 32, 34, 36
		OEM: 89516450

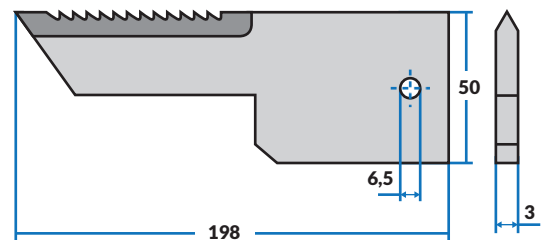

NR. AGV	OPIS	ZASTOSOWANIE
610190020	Nóż sieczkarni wygięty lewy (x1)	New Holland: CR 960, 980, CX 720, 740, 760, 780, 820, 840, 860, 880
		OEM: 87031976

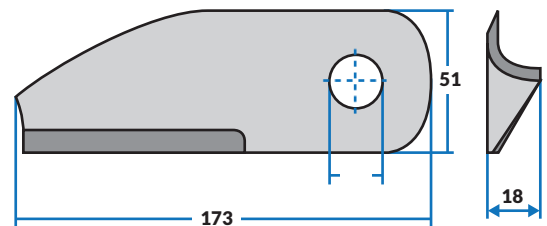

NR. AGV	OPIS	ZASTOSOWANIE
610190021	Nóż sieczkarni wygięty prawy (x1)	New Holland: CR 960, 980, CX 720, 740, 760, 780, 820, 840, 860, 880
		OEM: 87031978

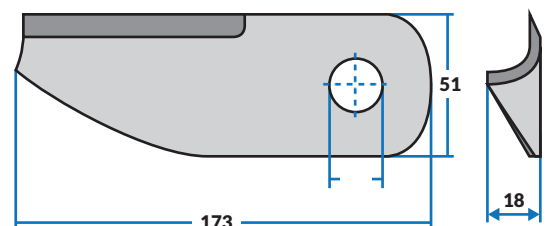

Noże do sieczkarni

Pasuje do NEW HOLLAND

NR. AGV	OPIS	ZASTOSOWANIE
610190022	Nóż sieczkarni stały (x2)	New Holland: CR 9060, 9070, 9080, 9090, CX 8030, 8040, 8050, 8060, 8070, 8080, 8090 OEM: 87318524

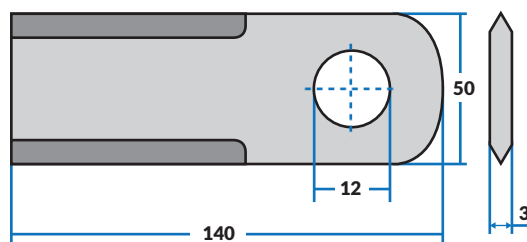

NR. AGV	OPIS	ZASTOSOWANIE
610190027	Nóż sieczkarni zębaty z uskokiem (x1)	New Holland: TX 36, 34, 32, 30, 62, 63, 64, 65, 66, 67, 68, CL 560, 6060, CS520, 540, 6050, 6060, 6060H, 6070, 6080, 6090, 640, 660, CSX 7040, 7050, 7050H, 7060, 7070, 7080, TC 52, 54, 56 OEM: 84037553

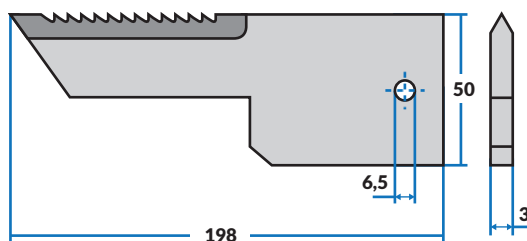

NR. AGV	OPIS	ZASTOSOWANIE
610190028	Nóż sieczkarni	New Holland: OEM:

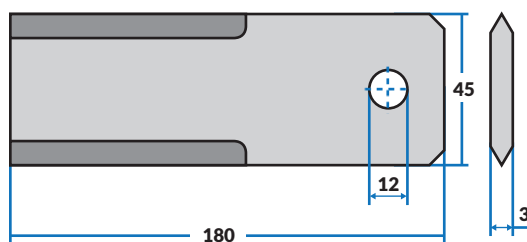

NR. AGV	OPIS	ZASTOSOWANIE
610190029	Nóż sieczkarni gładki	New Holland: OEM: 50028-4

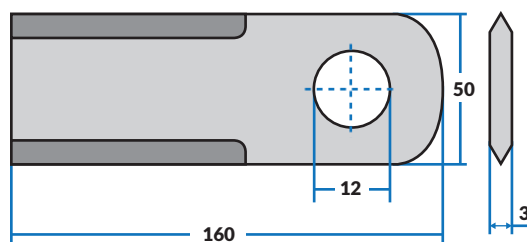

NR. AGV	OPIS	ZASTOSOWANIE
610190030	Nóż sieczkarni	New Holland: OEM:

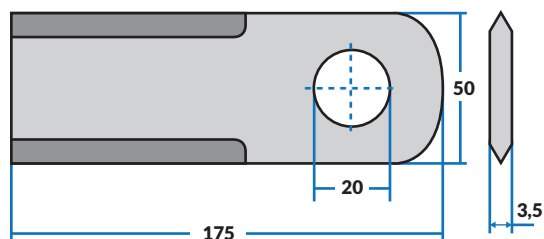

Pasuje do NEW HOLLAND

NR. AGV	OPIS	ZASTOSOWANIE
---------	------	--------------

610190033	Nóż sieczkarni zębaty (x3)	New Holland: TF 76, 78, TX 62, 63, 64, 65, 66, 67, 68
-----------	----------------------------	--

OEM: 89833966

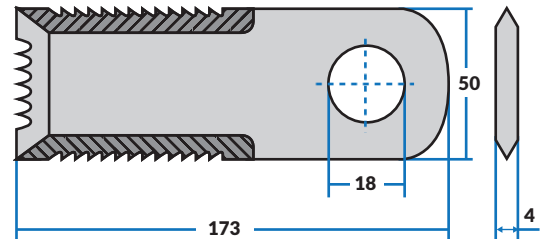

NR. AGV	OPIS	ZASTOSOWANIE
---------	------	--------------

610190035	Nóż sieczkarni	New Holland: CR 9080, 960, 980, CX 720, 740, 760, 780, 820, 840, 860, 880
-----------	----------------	--

OEM: 84437640

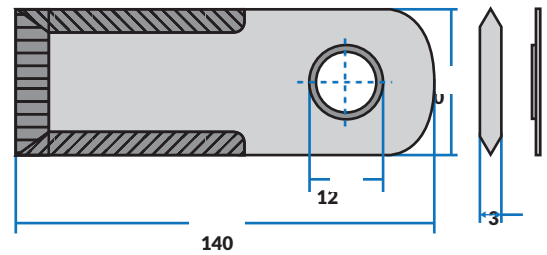

NR. AGV	OPIS	ZASTOSOWANIE
---------	------	--------------

610190001	Nóż sieczkarni gładki (x2)	New Holland: TX 30, 32, 34, 36
-----------	----------------------------	---------------------------------------

OEM: 80746813

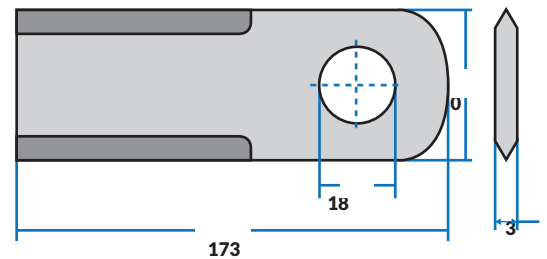

NR. AGV	OPIS	ZASTOSOWANIE
---------	------	--------------

610190002	Nóż sieczkarni gładki (x2)	New Holland: TX 30, 32, 34, 36
-----------	----------------------------	---------------------------------------

OEM: 80746805

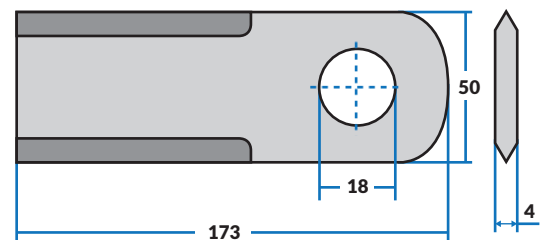

Noże do sieczkarni

AGV	OPIS	DŁUGOŚĆ (mm)	SZEROKOŚĆ (mm)	GRUBOŚĆ (mm)	Ø OTWORU (mm)
610190014	Nóż sieczkarni gładki (x1)	200	50	2,5	2x20
610190027	Nóż sieczkarni zębaty (x1)	198	50	3	6,5
610190016	Nóż sieczkarni gładki z uskokiem (x1)	198	50	3	6,5
610190017	Nóż sieczkarni zębaty z uskokiem (x1)	198	50	3	6,5
610190016	Nóż sieczkarni gładki z uskokiem (x1)	198	50	3	6,5
610190017	Nóż sieczkarni zębaty z uskokiem (x1)	198	50	3	6,5
610190027	Nóż sieczkarni zębaty z uskokiem (x1)	198	50	3	6,5
610190016	Nóż sieczkarni gładki z uskokiem (x1)	198	50	3	6,5
610190017	Nóż sieczkarni zębaty z uskokiem (x1)	198	50	3	6,5
610190027	Nóż sieczkarni zębaty z uskokiem (x1)	198	50	3	6,5
610190004	Nóż sieczkarni gładki (x2)	195	50	3	12
610190005	Nóż sieczkarni zębaty (x2)	195	50	3	12
610190004	Nóż sieczkarni gładki (x2)	195	50	3	12
610190005	Nóż sieczkarni zębaty (x2)	195	50	3	12
610190004	Nóż sieczkarni gładki (x2)	195	50	3	12
610190005	Nóż sieczkarni zębaty (x2)	195	50	3	12
610190004	Nóż sieczkarni gładki (x2)	195	50	3	12
610190005	Nóż sieczkarni zębaty (x2)	195	50	3	12
610190004	Nóż sieczkarni gładki (x2)	195	50	3	12
610190005	Nóż sieczkarni zębaty (x2)	195	50	3	12
610190039	Nóż sieczkarni zębaty	190	50	3	12
610190031/P	Nóż sieczkarni wygięty prawy (x1)	181	50	4,5	19,5
610190031/L	Nóż sieczkarni wygięty lewy (x1)	181	50	4,5	19,5
610190032	Nóż sieczkarni	180	50	3,3	19,7
610190028	Nóż sieczkarni	180	45	3	12
610190036	Nóż sieczkarni gładki	176	60	6	30
610190018	Nóż sieczkarni gładki ruchomy	175	50	4	20
610190019	Nóż sieczkarni gładki stały (x1)	175	40	3	10
610190007	Nóż sieczkarni gładki (x1)	175	40	3	10,5
610190024	Nóż sieczkarni zębaty z tulejką (x2)	175	50	4,5	20,1
610190025	Nóż sieczkarni gładki	175	50	4,5	20,1
610190038	Nóż sieczkarni gładki	175	40	3	10,5
610190010	Nóż sieczkarni gładki z tulejką (x2)	175	50	4	20
610190011	Nóż sieczkarni zębaty z tulejką (x2)	175	50	4	20
610190034	Nóż sieczkarni zębaty	175	50	4	20
610190037	Nóż sieczkarni gładki	175	50	4	20
610190015	Nóż sieczkarni zębaty (x3)	175	50	4,5	20,1
610190038	Nóż sieczkarni	175	40	3	10,5
610190015	Nóż sieczkarni zębaty (x3)	175	50	4,5	20,1
610190030	Nóż sieczkarni	175	50	3,5	20
610190012	Nóż sieczkarni zębaty (x2)	173	50	5	18
610190001	Nóż sieczkarni gładki 3 mm (x2)	173	50	3	18
610190002	Nóż sieczkarni gładki 4 mm (x2)	173	50	4	18

AGV	OPIS	DŁUGOŚĆ (mm)	SZEROKOŚĆ (mm)	GRUBOŚĆ (mm)	Ø OTWORU (mm)
610190003	Nóż sieczkarni zębaty (x2)	173	50	4	18
610190006	Nóż sieczkarni zębaty (x2)	173	50	3	18
610190009	Nóż sieczkarni gładki (x2)	173	50	4	20
610190001	Nóż sieczkarni gładki (x2)	173	50	3	18
610190002	Nóż sieczkarni gładki (x2)	173	50	4	18
610190003	Nóż sieczkarni zębaty (x2)	173	50	4	18
610190026	Nóż sieczkarni gładki	173	50	5	18
610190033	Nóż sieczkarni zębaty (x3)	173	50	4	18
610190001	Nóż sieczkarni gładki (x2)	173	50	3	18
610190002	Nóż sieczkarni gładki (x2)	173	50	4	18
610190003	Nóż sieczkarni zębaty (x2)	173	50	4	18
610190001	Nóż sieczkarni gładki (x2)	173	50	3	18
610190002	Nóż sieczkarni gładki (x2)	173	50	4	18
610190033	Nóż sieczkarni zębaty (x3)	173	50	4	18
610190001	Nóż sieczkarni gładki (x2)	173	50	3	18
610190002	Nóż sieczkarni gładki (x2)	173	50	4	18
610190001	Nóż sieczkarni gładki (x2)	173	50	3	18
610190002	Nóż sieczkarni gładki (x2)	173	50	4	18
610190003	Nóż sieczkarni zębaty (x2)	173	50	4	18
610190001	Nóż sieczkarni gładki (x2)	173	50	3	18
610190002	Nóż sieczkarni gładki (x2)	173	50	4	18
610190003	Nóż sieczkarni zębaty (x2)	173	50	4	18
610190001	Nóż sieczkarni gładki (x2)	173	50	3	18
610190002	Nóż sieczkarni gładki (x2)	173	50	4	18
610190003	Nóż sieczkarni zębaty (x2)	173	50	4	18
610190001	Nóż sieczkarni gładki (x2)	173	50	3	18
610190002	Nóż sieczkarni gładki (x2)	173	50	4	18
610190012	Nóż sieczkarni zębaty (x2)	173	50	5	18
610190013	Nóż sieczkarni zębaty (x2)	173	50	5	20,5
610190020	Nóż sieczkarni wygięty lewy (x1)	173	51	18	
610190021	Nóż sieczkarni wygięty prawy (x1)	173	51	18	
610190033	Nóż sieczkarni zębaty (x3)	173	50	4	18
610190001	Nóż sieczkarni gładki (x2)	173	50	3	18
610190002	Nóż sieczkarni gładki (x2)	173	50	4	18
610190008	Nóż sieczkarni gładki (x2)	166	50	3,5	20,1
610190029	Nóż sieczkarni gładki	160	50	3	12
610190022	Nóż sieczkarni stały (x2)	140	50	3	12
610190035	Nóż sieczkarni	140	50	3	12
610190023	Nóż sieczkarni (x2)	90	53	4	11

Tulejki do noża siewczarni

40-47

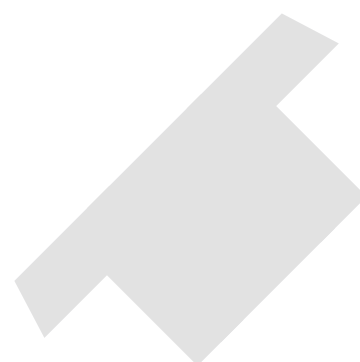

Tulejki do noża sieczkarni

Pasuje do BISO-SCHRATTENECKER

NR. AGV	OPIS	OEM
610193015	Tulejka noża sieczkarni	28.203.068.000 28-801-405-012/4

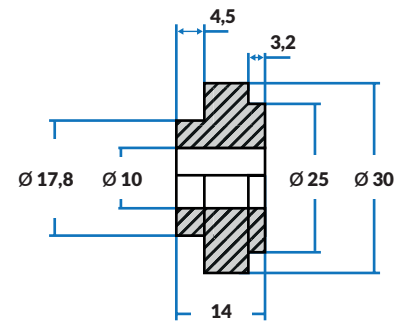

NR. AGV	OPIS	OEM
610193016	Tulejka noża sieczkarni	28.801.405.0012/3

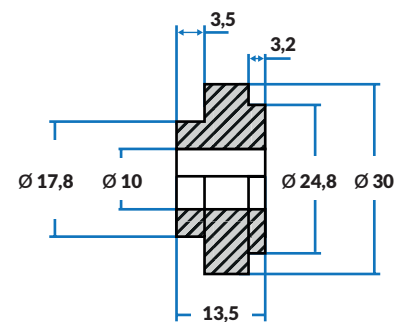

NR. AGV	OPIS	OEM
610193018	Tulejka noża sieczkarni	28.801.405.0013

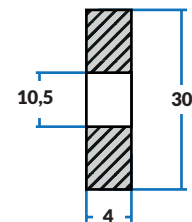

Pasuje do CASE

NR. AGV	OPIS	OEM
610193009	Tulejka noża sieczkarni	193362A1

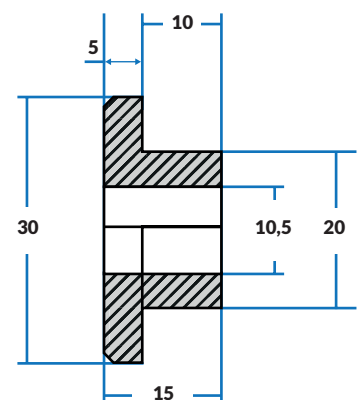

Tulejki do noża sieczkarni

Pasuje do CASE

NR. AGV	OPIS	OEM
610193010	Tulejka noża sieczkarni	1322242C1

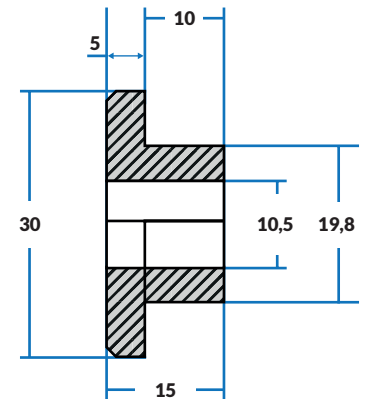

NR. AGV	OPIS	OEM
610193011	Tulejka noża sieczkarni	1994758C2

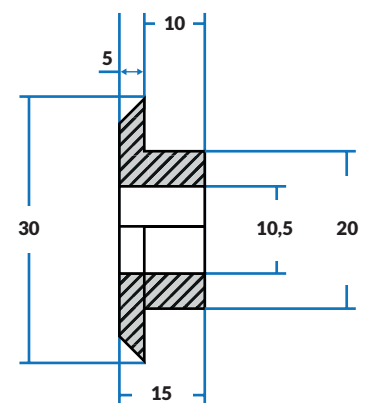

Pasuje do CLAAS

NR. AGV	OPIS	OEM
610193001	Tulejka noża sieczkarni	060 015.0

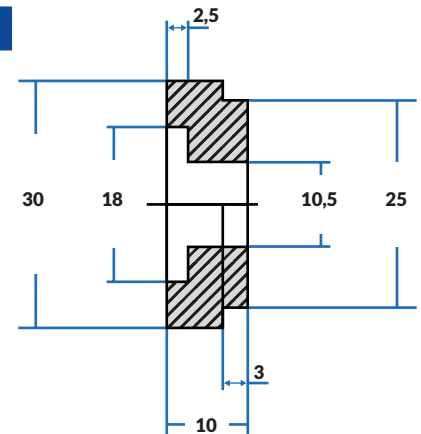

NR. AGV	OPIS	OEM
610193002	Tulejka noża sieczkarni	060 016.0/3

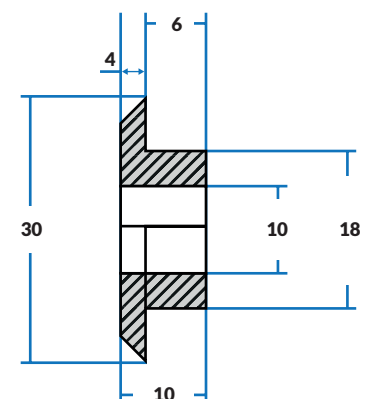

Tulejki do noża sieczkarni

Pasuje do CLAAS

NR. AGV	OPIS	OEM
610193003	Tulejka noża sieczkarni	060 016.0/4

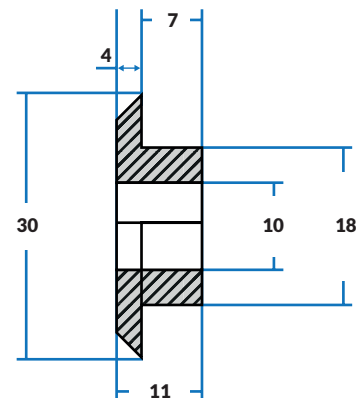

NR. AGV	OPIS	OEM
610193004	Tulejka noża sieczkarni	736 871.2

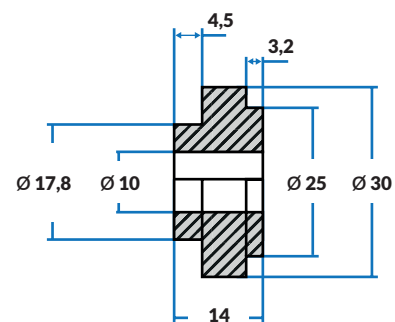

NR. AGV	OPIS	OEM
610193005	Tulejka noża sieczkarni	755869

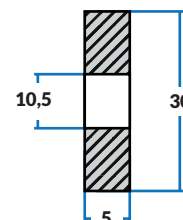

NR. AGV	OPIS	OEM
610193006	Tulejka noża sieczkarni	736922

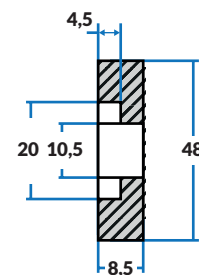

NR. AGV	OPIS	OEM
610193007	Tulejka noża sieczkarni	755860

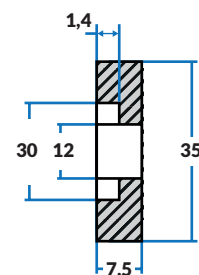

Tulejki do noża sieczkarni

Pasuje do CLAAS

NR. AGV	OPIS	OEM
610193008	Tulejka noża sieczkarni	755861

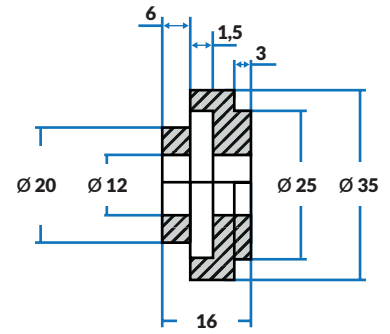

Pasuje do CASE

NR. AGV	OPIS	OEM
610193009	Tulejka noża sieczkarni	193362A1

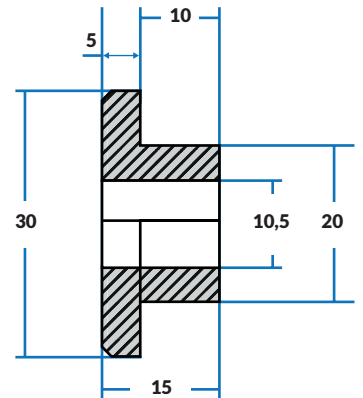

NR. AGV	OPIS	OEM
610193010	Tulejka noża sieczkarni	1322242C1

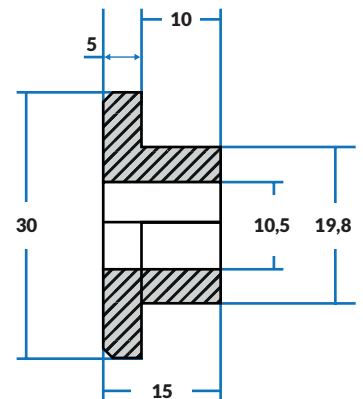

NR. AGV	OPIS	OEM
610193011	Tulejka noża sieczkarni	1994758C2

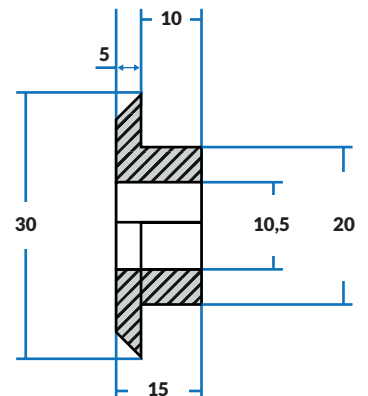

Tulejki do noża sieczkarni

Pasuje do JOHN DEERE

NR. AGV	OPIS	OEM
610193015	Tulejka noża sieczkarni	Z51243

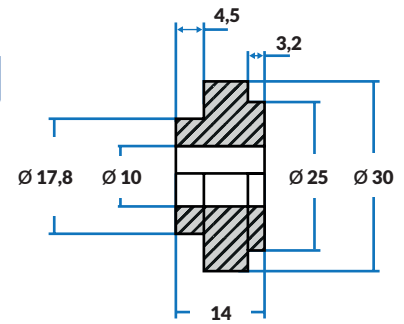

NR. AGV	OPIS	OEM
610193016	Tulejka noża sieczkarni	Z35216

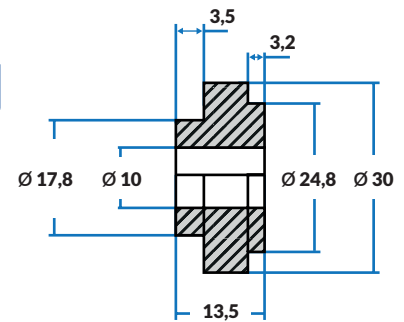

NR. AGV	OPIS	OEM
610193017	Tulejka noża sieczkarni	Z42175

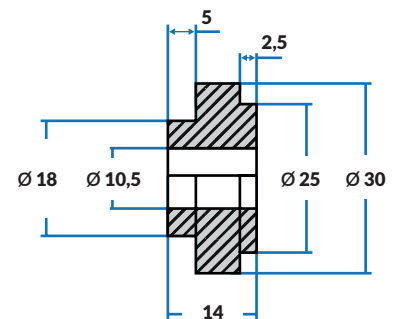

NR. AGV	OPIS	OEM
610193018	Tulejka noża sieczkarni	Z35217

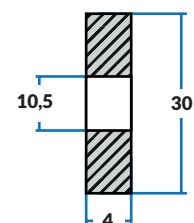

Tulejki do noża sieczkarni

Pasuje do LAVERDA

NR. AGV	OPIS	OEM
610193012	Tulejka noża sieczkarni	320997850

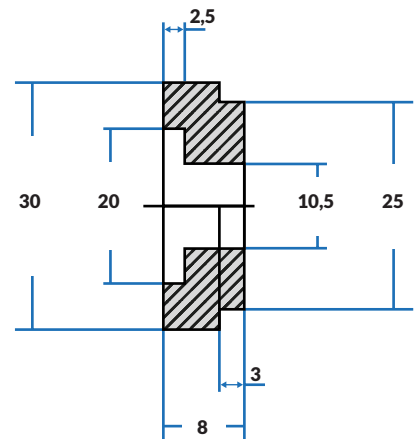

NR. AGV	OPIS	OEM
610193013	Tulejka noża sieczkarni	320999450

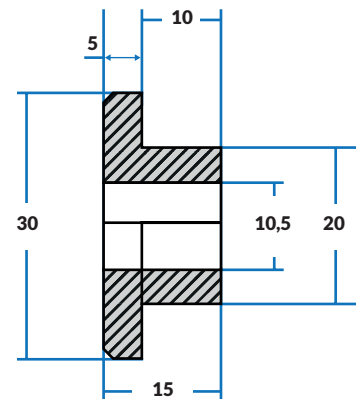

Pasuje do NEW HOLLAND

NR. AGV	OPIS	OEM
610193014	Tulejka noża sieczkarni	80746732

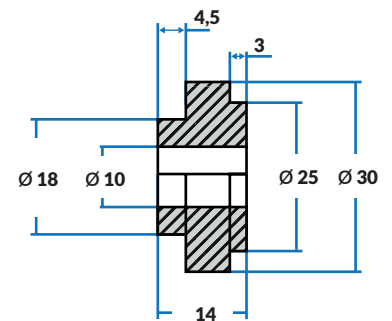

NR. AGV	OPIS	OEM
610193015	Tulejka noża sieczkarni	84433270

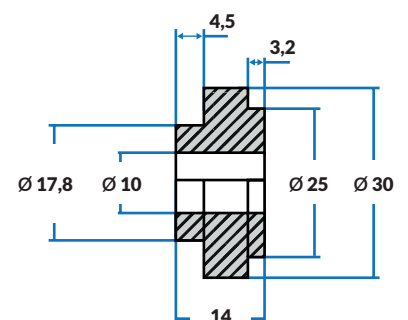

Our E-commerce platform is the perfect solution to find the part required at any time of the day, seven days a week



We offer our customers a number of methods to find the right part:

- + OEM or manufacturer number
- + Description
- + Tractor or engine model

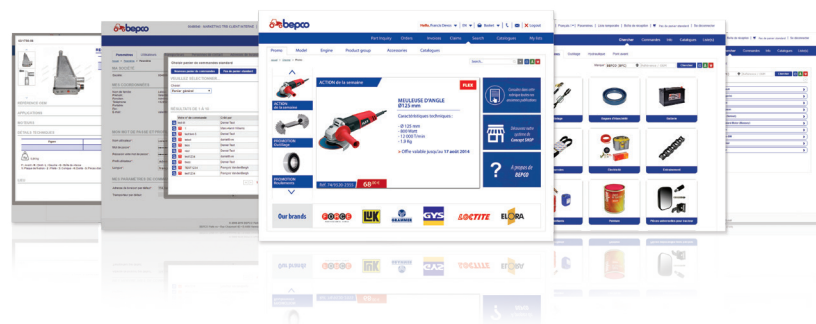

We are constantly developing our E-Commerce platform with new products and offers to improve customers' daily use. Clear product images, precise technical details and comprehensive tractor applications make daily work that much easier.

To find out more about Bepco and how we can help your business visit us online at www.bepcoparts.com or contact a member of our local sales team.

- + Technical parts produced 100% in Europe
- + AGV stands for quality approved by Bepco Team
- + Stock in local warehouses to ensure good local service all year round and especially during harvest
- + Central warehouse allowing D+1 delivery and 24/7 during harvest
- + Technical expertise with trained technicians

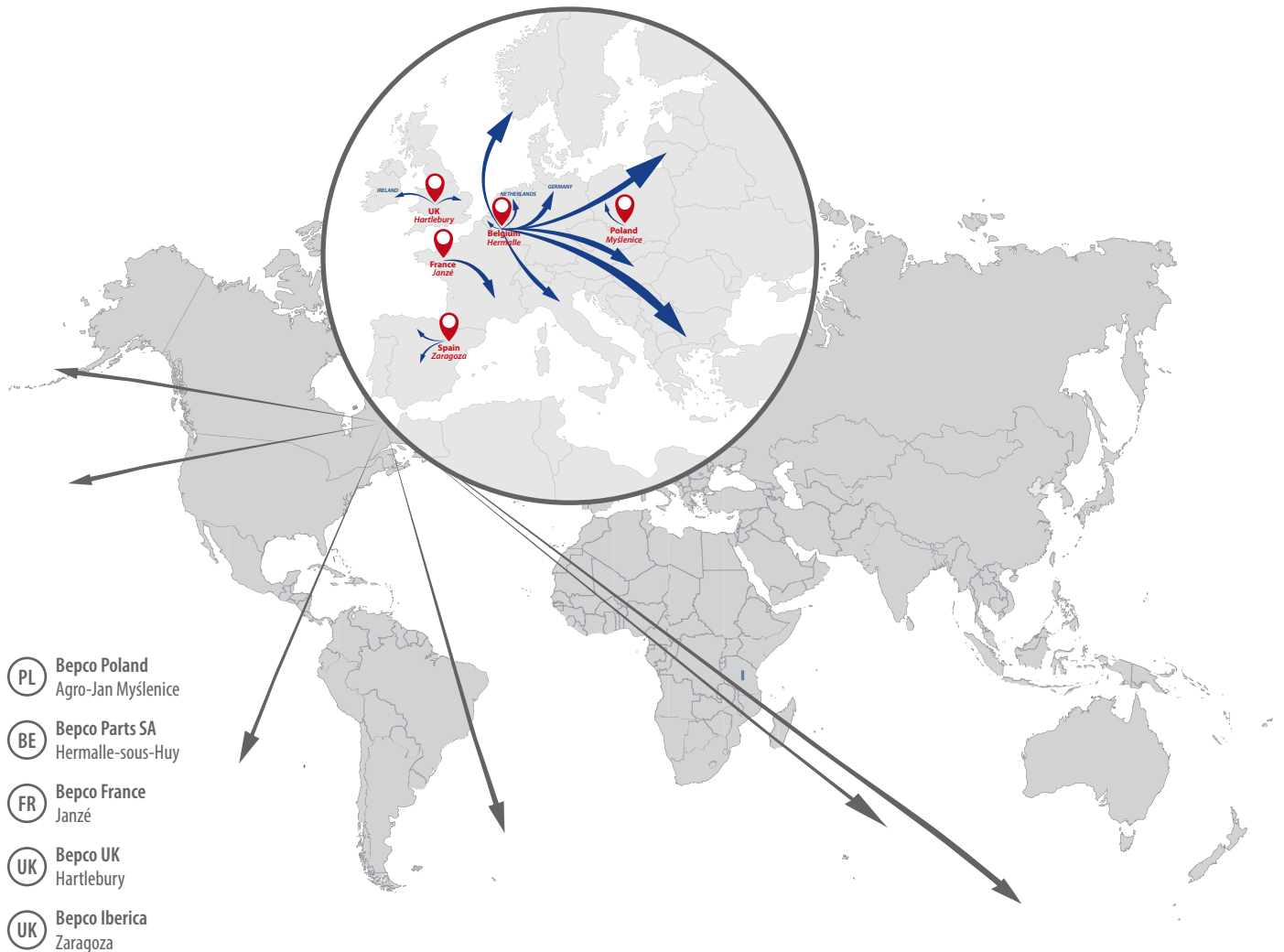

We deliver next day to customers from stock in local warehouses

Global reach, local service

Our Subsidiaries



BEPKO PARTS SA

HERMALLE-SOUS-HUY

Rue Chaumont, 4D • 4480 Hermalle-sous-Huy • Belgique
T +32 85 24 54 00 • F +32 85 24 54 50
info.be@bepcoparts.com • www.bepcoparts.com

VILLERS-LE-BOUILLET

Rue de Waremmes, 114 • 4530 Villers-le-Bouillet • Belgique
T +32 85 24 54 00 • F +32 85 24 54 50
info.be@bepcoparts.com • www.bepcoparts.com



BEPKO UK LTD

Bepco House • Unit 316 • Hartlebury Trading Estate
Hartlebury - Worcestershire, DY10 4JB (UK)
P +44 (0)1299 252270 • F 0800 216553
info.uk@bepcoparts.com • www.bepcoparts.com



BEPKO FRANCE SAS

Z.I. La Plaine, Allée de Bigorre
BP80041 Le Passage • 47901 Agen Cedex 9 • France
T +33 (0)5 53 96 31 25 • F +33 (0)5 53 68 03 72
info.fr@bepcoparts.com • www.bepcoparts.com

VILLENEUVE-SUR-LOT

294 Av. de Bordeaux • CS 30059 Bias
FR-47302 Villeneuve sur lot • France
T +33 (0)5 53 40 37 50 • F +33 (0)5 53 70 61 93

JANZÉ

P.A. de la Chauvelière • Rue Charles Lindbergh, 21
35150 JANZE • France
T + 33 (0)2 99 44 16 18 • F +33 (0)2 99 44 17 29



BEPKO DEUTSCHLAND GmbH

Nelmannwall 4 • 59494 Soest • Germany
T +49 (0)2927 919 59 0 • F +49 (0)2927 919 59 59
info.de@bepcoparts.com • www.bepcoparts.com



BEPKO NEDERLAND BV

Den Dolvert 10 • 5473 GP, Heeswijk-Dinther • Nederland
T +31 (0)413 29 39 75 • F +31 (0)413 29 40 87
info.nl@bepcoparts.com • www.bepcoparts.com



BEPKO IBÉRICA SA

BADALONA

C/ Torrent de Vallmajor, 82
08915 Badalona (Barcelona) • España
T +34 902 111 062 - 933 810 062 • F +34 933 813 345
info.es@bepcoparts.com • www.bepcoparts.com

SANTIAGO DE COMPOSTELA

Pol. El Tambre, Via Faraday, 36
15890 Santiago de Compostela • España
T +34 902 111 062 - 981 560 012

ALMENDRALEJO

Ctra. Badajoz - Pol. Rayvaz Nave 21
06200 Almendralejo (Badajoz) • España
T +34 902 111 062 - 924 664 890
F +34 924 664 576

DOS HERMANAS

Pol. Ind. La Isla, C/ Hornos, 11
41703 Dos Hermanas (Sevilla) • España
T +34 902 111 062 - 954 931 546
F +34 954 930 130

ZARAGOZA

Pol. Ind. Plaza, C/ Pertusa, 29
50197 Zaragoza • España
T +34 902 111 062 - 876 903 874
F +34 876 903 873

PAMPLONA

Polígono Agustinos Calle A Nave D-13
31013 Pamplona (Navarra) • España
T +34 948 312 318
F +34 948 312 341



BEPKO POLSKA

Ul. Burmistrza Andrzeja Marka 5 • PL-32-400 MYŚLENICE
T +48 (12) 211 44 44
biuro@bepco.pl • www.bepcoparts.com



BEPKO ROMANIA

Zona Industrială DIBO • Hala nr.8 • Sat. Negoiesti, Com. Brazi
Jud. Prahova • Romania
T +40 (0)786 53 00 06 • F +40 (0)244 43 42 78



BEPKO UKRAINE

Ternopil blast • vul.Gayova 54 • Ternopol 46000 • Ukraine
T +38 (0)676 736 300 • F +38 (0)352 251 726
T +40 (0)786 53 00 06 • F +40 (0)244 43 42 78



TVH PARTS SOUTH AFRICA (Pty) Ltd

HEAD OFFICE Johannesburg

CAPE TOWN

1 Karee Street • Kraaifontein Industries • Cape Town 7571
T +27 21 988 2432 • F +27 21 988 9127
capetownsales@tvh.com

DURBAN

2 Monaco Place • Westmead • Pinetown 3600
T +27 31 100 0760 • F +27 31 700 6191
durbansales@tvh.com

JOHANNESBURG

90 Electron Avenue • Isando • Kempton Park 1601
T +27 11 281 27 00 • F +011 974 9845
johannesburgsales@tvh.com

LICHTENBURG

Shop 1 • 109 Scholtz Street • Lichtenburg 2740
T +27 18 632 6192/6092 • F +27 18 632 6108
lichtenburgsales@tvh.com

PORT ELIZABETH

134 Kempston Road • Korsten • Port Elizabeth 6020
T +27 41 453 1404/8 • F +27 41 453 1409
portelizabethsales@tvh.com



TVH AUSTRALIA PTY LTD

HEAD OFFICE BRISBANE

ADELAIDE

96 South Terrace • Wingfield SA 5013
Free 1800 182 344 • T +61 8 8359 8933 • F +61 8 8234 2212
BepcoSAsales@tvh.com.au

BRISBANE

735 Boundary Road • Richlands QLD 4077
Free 1800 020 082 • T +61 7 3344 1113 • F +61 7 3344 1332
BepcoQLDsales@tvh.com.au

MELBOURNE

7/66-74 Micro Circuit • Dandenong South VIC 3175
Free 1800 802 367 • T +61 3 9796 5422 • F +61 3 9796 5251
BepcoVICsales@tvh.com.au

PERTH

2/15 Colin Jamieson Drive • Welshpool WA 6106
Free 1800 182 344 • T +61 8 8352 8984 • F +61 8 8234 2212
BepcoWAsales@tvh.com.au

SYDNEY

1/1002-1010 Canley Vale Rd • Wetherill Park NSW 2164
Free 1800 808 827 • T +61 2 6885 5288 • F +61 3 9796 5251
BepcoNSWsales@tvh.com.au



TVH NEW ZEALAND LTD







































AUCKLAND

PO Box 51490 • Pakuranga 2140
80 Lady Ruby Drive • East Tamaki 2013 • Auckland
Free 0800 459 662 • T +64 9 274 9695 • F +64 9 274 9698
info@tvh.co.nz • www.tvh.com

CHRISTCHURCH

11C Parkhouse Road
Wigram • Christchurch 8042
Free 0508 8 722 867 • T +64 3 550 1298 • F +64 3 974 9993
infochch@tvh.co.nz

Our range of Harvesting Machinery Parts

	Claas / New Holland / John Deere	Aftermarket	OPM
Main product families		Filter	  
		Belts	 
		Chains	
		Sprockets	
		Concaves	
		Rasp bars	
		Fingers	
		Sieves	
		Sensors	
		Knife sections	  
		Tie rods	 
		Shafts	
		Clutch, couplings	  
		Crop lifters	
		Bearings and housings	  
		Straw chopper knives	 
		Glass	



Industry leading brands ensuring quality and reliability



Zastrzegamy sobie prawo do zmian danych technicznych i ewentualnych błędów. Sprzedaż prowadzimy do wyczerpania zapasów.



The spare parts mentioned in this list can normally be delivered from stock. In addition, we can supply parts, which are not mentioned in this catalogue, with the shortest possible delivery time. The O.E.M. references are only for indication purposes and do not imply that the spare parts are coming from the manufacturer. This spare parts list can be modified without prior notice. All photographs, drawings, illustrations, brand names, descriptions and numbers are included for identification purposes only.



De onderdelen vermeld in deze lijst, zijn normaal uit voorraad leverbaar, behoudens uitverkocht. Ook niet-vermelde onderdelen kunnen binnen de kortste tijd uitgeleverd worden. De O.E.M. referenties dienen enkel ter indicatie en impliceren niet dat deze van de vermelde constructeur afkomstig zijn. Deze onderdelenlijst kan zonder enige voorafgaande verwittiging aangepast worden. Alle gebruikte foto's, tekeningen, afbeeldingen, merknamen, omschrijvingen en nummers dienen alleen ter identificatie.



Les pièces de rechange, mentionnées dans cette liste, sont normalement livrables du stock. En plus, les articles nonindiqués peuvent être fournis en peu de temps. Cette liste peut être modifiée sans avis préalable. Les références O.E.M. sont seulement indicatives et n'impliquent pas que les pièces de rechange viennent du constructeur. Toutes les photographies, illustrations, marques, descriptions, tous les plans et numéros servent exclusivement à une identification.



Die in dieser Liste aufgeführten Teile sind normalerweise aus dem Lager lieferbar. Wir sind zudem in der Lage nicht aufgeführte Teile innerhalb kürzester Zeit zu liefern. Die O.E.M. Referenznummern dienen zur Information und beinhalten nicht, dass diese vom genannten Hersteller kommen. Diese Bestandsliste kann ohne vorhergehende Ankündigung geändert werden. Alle verwendeten Fotos, Zeichnungen, Abbildungen, Markennamen, Beschreibungen und Nummern dienen nur zu Identifikationszwecken.



Los artículos mencionados en este catálogo se encuentran habitualmente en stock. Además, podemos suministrar en un plazo corto de tiempo otros artículos relacionados que no se encuentren expresamente mencionados en este catálogo. Las referencias O.E.M. sirven sólo como indicación y no implican que procedan del constructor. Este listado de productos puede estar sujeto a modificaciones sin aviso previo. Todas las fotos, dibujos, ilustraciones, nombres de marca, descripciones y números se han incluido simplemente con el propósito de su identificación.



I pezzi di ricambio, menzionati in questo listino, possono essere forniti con una consegna immediata a condizione che non siano esauriti. I pezzi di ricambio non menzionati possono essere forniti in poco tempo. Le referenze O.E.M. sono solamente indicative e non implicano che i pezzi di ricambio vengano da questo costruttore. Questa lista ricambi può essere aggiustata senza avvisi anticipati. Tutti i numeri, codici, nomi, foto, spaccati e disegni sono solo a titolo informativo.



Części z tego katalogu są zazwyczaj na stanie magazynowym. Również części które nie są wyszczególnione w katalogu mogą być dostarczone na zamówienie w najkrótszym możliwym terminie. Opis części O.E.M. jest używany informacyjnie i nie wskazuje na to, że dany produkt jest wyprodukowany przez podanego producenta. Zawartość katalogu może ulec zmianie bez wcześniejszego informowania o tym. Wszystkie użyte zdjęcia, rysunki, nazwy marek, opis i numery służą tylko do identyfikacji.



Запчасти из настоящего списка, как правило, имеются в запасе, если только он не распродан. Прочие, не фигурирующие в списке артикулы, могут быть поставлены в самые кратчайшие сроки. Указание оригинальных номеров производителя не предполагает обязательного оригинального происхождения самих деталей. Данный список может изменяться без предварительного уведомления. Все использованные фото, рисунки, иллюстрации, названия брендов, наименования и номера служат исключительно для цели идентификации.



Visit us on the web :
WWW.BEPCOPARTS.COM

© bepco 2019

All rights reserved. Reproduction, in whole or in part, or the entry/use in an information storage system or retrieval system is allowed only with the written approval of Bepco Deutschland GmbH.

- BEPCO is a supplier of after-market spare parts and accessories for the maintenance and repair of OEM equipment. OEM spare part numbers are used only for comparison purposes. The supplied spare parts are not original spare parts, unless otherwise specified.
- The photos and illustrations are used only as reference. Errors and misprints excepted.
- BEPCO® is a registered trademark
- All sales are subject to the general commercial terms and conditions - available on www.bepcoparts.com
- Goods delivery only as long as stock lasts

*Części zamienne od A-Z
do wszystkich marek*

• **Kombajny**

- Części do ciągników
- Części silnika
- Hydraulika
- Klimatyzacja
- Warsztat
- Materiały eksploatacyjne i akcesoria
- Części zużywające się

WWW.BEPCOPARTS.COM



BEPCO POLSKA SP. Z O.O.

ul. Burmistrza Andrzeja Marka 5 • 32-400 Myślenice • Poland

T +48 (12) 211 44 44 • F +48 (12) 211 44 45 • info.pl@bepcoparts.com • www.bepcoparts.com

Member of

